

2017 MAZDA MX-5 MIATA



mazda

DRIVING MATTERS®

ZOOM-ZOOM

DOES DRIVING MATTER?

Does a long, winding road or an empty freeway on Sunday morning matter if the car you're in doesn't take advantage of the moment?

Does safety, technology, efficiency or even beauty matter, if a car doesn't feel right in your hands?

If you build Mazdas, driving is what matters most.

That's why everything we do makes driving better.

Like safety technology that inspires confidence.

Engine technology that makes our cars and SUVs more fuel-efficient. Yet still responsive.

And designs that capture motion, even when the car isn't moving.

What's better than a great driving car?

A car company that won't build anything less.

MAZDA. DRIVING MATTERS®



WOULD THE WORLD BE A
BETTER PLACE IF EVERYONE
DROVE A ROADSTER?

IS OBSESSING OVER EVERY BOLT, EVERY WIRE AND EVERY STITCH OVERKILL? WE THINK NOT.

We built this Mazda MX-5 Miata like we built the very first one. We preserved our roots, but evolved the technology. We built a roadster with beautiful proportions, heart-pounding excitement, a rocking power-to-weight ratio and a connection to the road unlike any other. The Mazda MX-5 Miata is built this way because Driving Matters. It matters to you. And it matters to Mazda.

The MX-5 Miata commits to the asphalt with swift agility and nimble smoothness, without hesitation. Without excessive weight. It's how we've always done it. It's how it makes you feel when you grip the steering wheel and take a curvy off-ramp after a long day. We built the MX-5 to behave precisely how you, the driver, would want it to. Intuitive. Responsive. And how it just simply makes you grin from ear to ear. The value of driving dynamics is something you measure with your senses.

We built the MX-5 Miata for the s-curves. The corners. The cliff side highway corkscrews. Taking them confidently and never holding back. The MX-5 is an athletic 2,332 lbs! Light. Lean. Lively. And loaded with as much thrill as you want to give it. We built the Mazda MX-5 Miata because Driving Matters.

*Manual Transmission only.



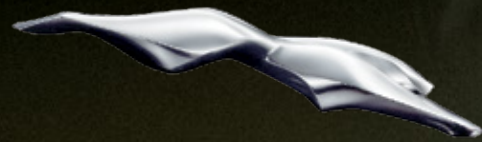

<

KODO: "Soul of Motion." Energy in motion. Power in motion. It's the inspiration behind the design of every Mazda vehicle. Created to transform ordinary sheet metal into something that embodies the vitality of a living being, KODO exudes the power and elegance of a wild animal in the instant before it pounces on its prey.

魂動

KODO : SOUL OF MOTION



Mazda MX-5 Miata Grand Touring shown in Soul Red Metallic

EXHILARATING. WITHOUT MOVING AN INCH.

The KODO: "Soul of Motion" design language is not just a curve in the side panels or the shape of a headlamp. You'll find it captured in every detail of the MX-5. Whether the top is up or folded neatly away, the muscular stance conveys an aggressive design while maintaining a fluid symmetry.

Beyond its exterior, the KODO motif resonates within the doors of the MX-5 Miata. The body color pours from the outside into the

interior for a fluid milieu, helping you become one with the vehicle. From the structure, stitching and fabric created for the seats, to the winged shape of the instrument panel and every surrounding surface before you, the environment conveys that this is no ordinary experience. Because having a presence on the road and being connected to everything around you makes driving better.

>

HEADLIGHT

Because we crafted one of the world's shortest and lowest noses on a sports car, fitting the headlamps into this extremely short overhang meant reinventing the headlight. The position of each LED bulb, the parabolic-type LED high beam and the turn signal layout produce better visibility and more intensity. We can't see accepting anything less than crisp, radiant light distribution.

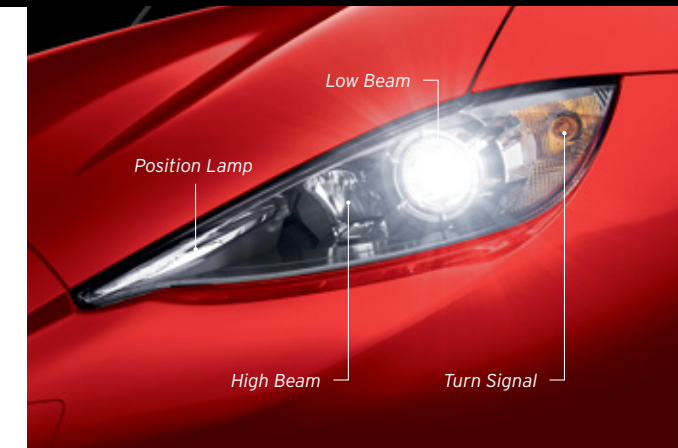

IS THE SHORTEST DISTANCE BETWEEN TWO POINTS REALLY THE BEST ROUTE?

What is it about the MX-5 Miata that makes you want to drive just a little bit longer? After evolving for 27 years, you learn a few things about what matters. Take it from longtime MX-5 Chief Program Manager Nobuhiro Yamamoto. Not only was he on the high-profile Mazda R&D team for the 1991 Le Mans win, he leads the team today in its obsessive need to achieve absolute performance and sheer driving excitement. Of his winning strategy, Yamamoto explains, "That means a light, compact body, front midship engine and rear-wheel drive, 50/50 weight distribution, low yaw moment of inertia, and low center of gravity." Winning races, and the hearts of fans the world over, appears to keep working.

Meticulous adjustments, such as lowering the engine for a lower center of gravity and pushing the engine back, are all nuances that keep us continually developing the MX-5 so it enhances balance and directional control, and stays firmly anchored to the pavement.

And because we race everything we build, you can be assured there's a track-tuned suspension that delivers superb handling and directional stability by combining a sophisticated double-wishbone layout up front with an advanced multilink setup in the rear.

The Dynamic Stability Control¹ with an integrated Traction Control System optimizes both traction and handling in less-than-ideal road conditions without interfering with your oneness with the road. For all those twists and turns the road has in store, each and every MX-5 is precisely engineered to create balance.



¹Dynamic Stability Control (DSC) is an electronic system designed to help the driver maintain control under adverse conditions. It is not a substitute for safe driving practices. Factors including speed, road conditions and driver steering input can all affect whether DSC will be effective in preventing loss of control. Please see your Owner's Manual for further details.

Mazda MX-5 Miata Grand Touring shown in Soul Red Metallic.

50/50

NEAR-PERFECTLY BALANCED? NOT UNTIL YOU GET BEHIND THE WHEEL.



HOW CAN OBSESSION CREATE BALANCE?

Even after 27 years, the engineers at Mazda remain passionate about the MX-5 Miata's near-perfect 50/50 front-to-rear weight distribution. The quality-obsessed engineers who imagined and built the latest generation MX-5 Miata held fast to one simple philosophy: Preserve and innovate the front-midship engine and rear-wheel drive layout. Sustaining the deep-rooted belief that the MX-5 is not perfectly balanced until you, the driver, are literally sitting in the driver's seat.

IS IT POSSIBLE TO IMPROVE THE BEST-SELLING ROADSTER OF ALL TIME?

The respected and fundamental driving dynamics of the Mazda MX-5 are fueled by the need to build a sports car that's lightweight, strong and a total blast to drive. All simply because Driving Matters. It's in our DNA to build cars that are responsive and faithful, which is why it's no wonder the MX-5 inspired the holistic approach to building our vehicles, called SKYACTIV® TECHNOLOGY.

SKYACTIV TECHNOLOGY makes for a lighter, stiffer and safer vehicle. And it is at the heart of the MX-5 Miata. Or is it the other way around? It's the foundation for a strong, lightweight platform with powerful-yet-efficient drivetrain that maximizes driving enjoyment with every drop of fuel. While you may not think about these aspects when you're tearing it up on a canyon curve, it matters to us that you get the most out of your sports car.



SKYACTIV ENGINE

The MX-5 Miata gets the most out of its dedicated engine with a 13.0:1 compression ratio and 4-2-1 race-inspired headers. This energizing 2.0-liter 16-valve DOHC engine delivers an assertive 155 hp and 6,000 rpm redline without sacrificing fuel efficiency, offering up to an EPA-estimated 35 highway MPG! The numbers may change, but the experience remains.



SKYACTIV-MT

The distinctive *jinba ittai* experience is fully realized behind the wheel, in the MX-5's precise and ultra-responsive short-throw, close-ratio 6-speed manual gearbox. With a mere flick of your wrist, shifting from gear to gear is not only rapid and precise, but a total blast. Smaller, lighter and smoother than any we've ever built before, even the compact design of the knob has an overall weight of 300 grams. Working harmoniously, the shifter, accelerator and clutch orchestrate a tempo with the driver that is unparalleled.



A COMPLETE BODY OF WORK

The MX-5's purposeful body design isn't strictly for aesthetics. It's the minutiae that MX-5 engineers get obsessive about because it matters in g-forces. And when entering turns, having a precise grasp of your exact position should never be guesswork. By expanding the field of vision, we gave the front fenders high-rising edges and a lower hood to allow for accurate tire placement, so you aim the MX-5 and it responds in accord.

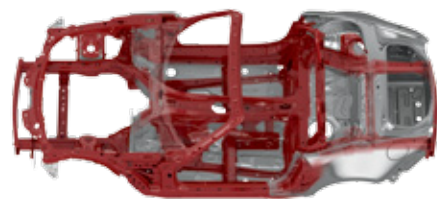

SKYACTIV-BODY

For the iconic MX-5 Miata, the challenge was to attain a lightweight, open-top sports car that felt responsive at every turn, yet minimized vibration. We crafted a sturdier structural design that used ultra-high tensile and high tensile steel in critical areas, while high-strength 7000-series aluminum materials replaced heavier steel at the front and rear bumper support, front fenders, brace bar, bulkhead and diagonal braces. The aluminum roof materials even help lower the center of gravity.

1

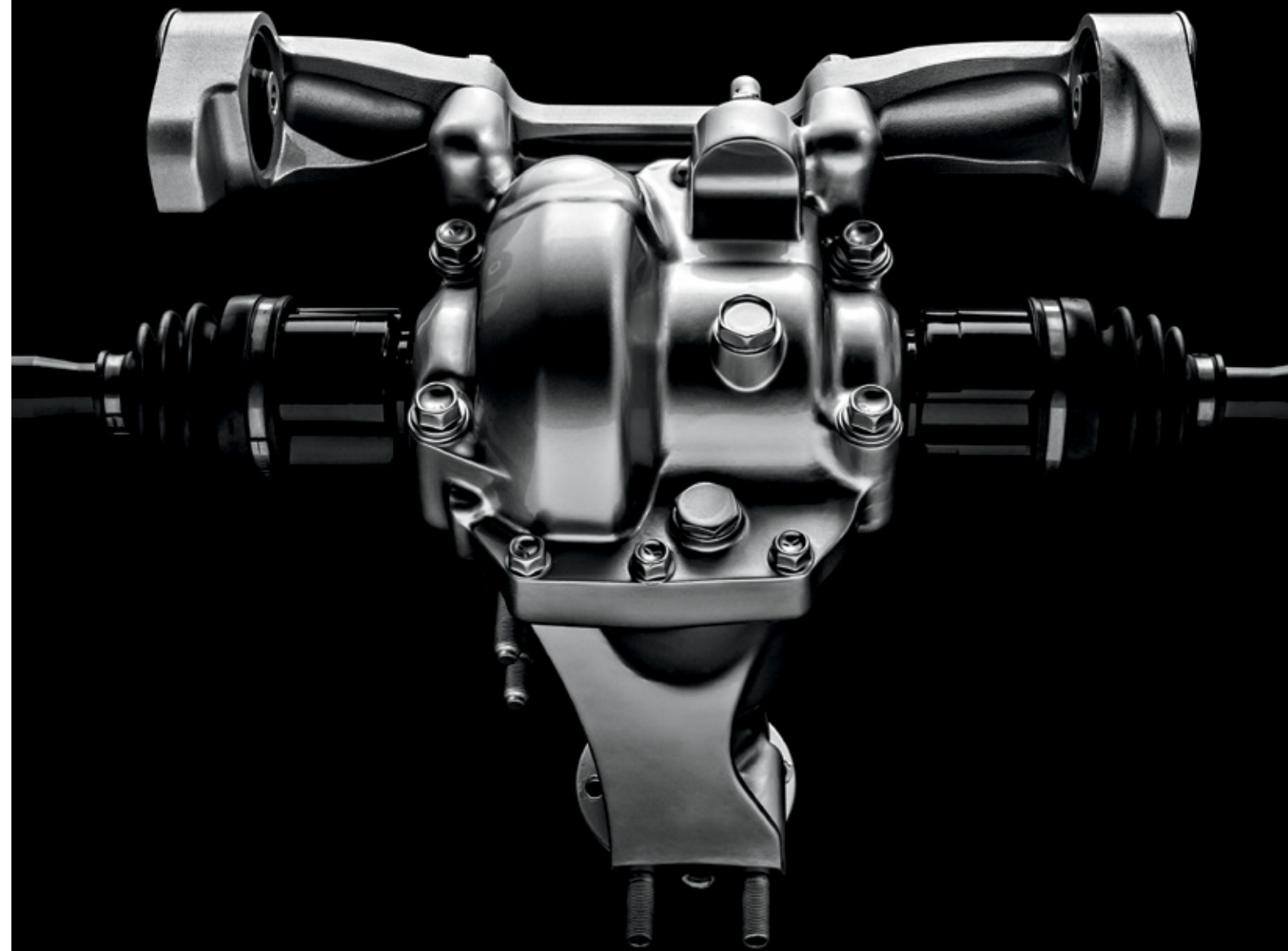

SKYACTIV TECHNOLOGY

UP TO AN EPA-ESTIMATED

35 HWY MPG¹

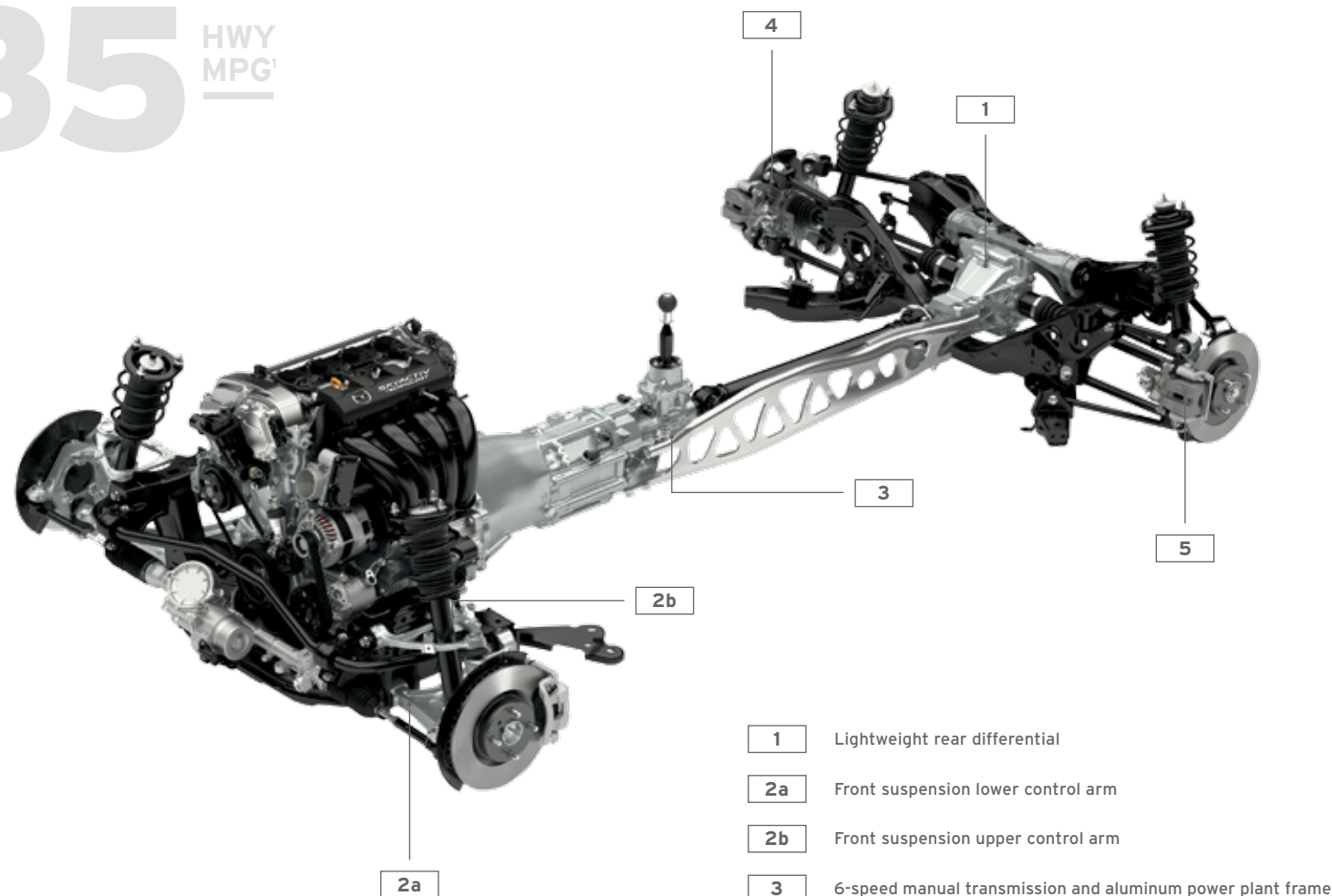

- 1 Lightweight rear differential
- 2a Front suspension lower control arm
- 2b Front suspension upper control arm
- 3 6-speed manual transmission and aluminum power plant frame
- 4 Aluminum rear suspension knuckle
- 5 Rear multilink suspension

^

SKYACTIV-CHASSIS

Getting the details just right is a Mazda engineer's sole purpose. And for the MX-5, that includes details in the design marvels that are the highly rigid and lightweight double wishbone front suspension and multilink rear suspension. Adopting aluminum for the upper arms, lower arms and knuckles, and 780 MPa-grade high-tensile steel for the crossmember, also contributes to making the MX-5 lighter, yet stronger.

Engineered to work in perfect harmony, the steering and suspension systems achieve two seemingly contradictory goals at once: to be nimble at low speeds, yet stable at high speeds, optimizing performance in those corners. And we kept refining millimeter-by-millimeter, and ounce-by-ounce, until optimum vehicle posture and vibration-dampening performance were achieved.

^

POWER PLANT FRAME

This structural "backbone" helps eliminate drivetrain twist, which wastes power and produces acceleration lag. The MX-5 Miata's ingenious aluminum Power Plant Frame that unites its engine, transmission and rear differential is light, yet rigid and stable. Plus reshaping the cross-section of the frame helps the MX-5 provide an unparalleled driving experience. You'll feel the responsiveness and feedback—from your right foot to your fingers wrapped around the steering wheel, up to the hairs on the back of your neck.

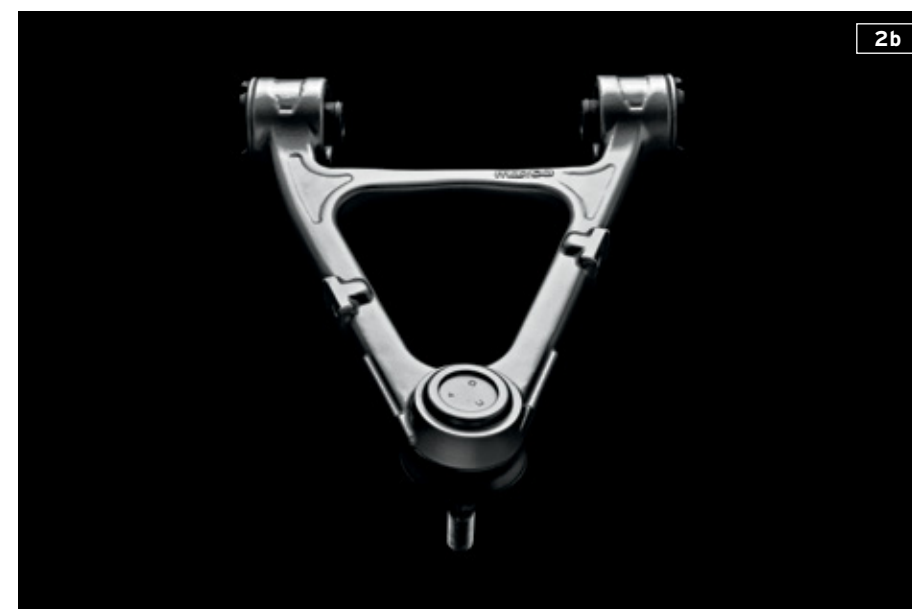

¹Based on EPA estimates for 2017 Mazda MX-5 Miata models with automatic transmission 26 city/35 highway MPG. Actual results will vary.



THE MAZDA MX-5 MIATA CLUB.

Enter the Mazda MX-5 Miata Club. Extraordinarily ready for the track or the streets. Things get more aggressive and athletic with a sport-tuned suspension and Bilstein® shock absorbers and a torque-sensing limited-slip differential! Delivering impeccable handling and near-telepathic control matters when carving up a curvy deserted highway. It is essential. And we won't build anything less.

Sure, the seductive appearance of the black-painted front air dam, side sill extensions and rear lip spoiler complete the aerodynamic

look, but the available Brembo®/BBS package on the Club model! not only turns heads, but turns corners with relentless agility. Lightweight, forged BBS 17" Gunmetal Alloy wheels give you even more confidence and control in concert with the Brembo high performance, fade-resistant ventilated front disc brakes. Because performance matters, especially when stopping.



Mazda MX-5 Miata Club shown in Ceramic Metallic with available Brembo/BBS Package

¹Manual Transmission only.



OBJECTS IN MIRROR HAVE BEEN TRYING TO CATCH UP FOR MORE THAN TWO DECADES.

The fact that the MX-5 Miata has been racing for its entire 27-year history relates directly to another amazing fact: On any given weekend, more Mazdas and Mazda-powered cars are road-raced in the U.S. than any other car.¹ And in terms of pro racing, 2016 marks the eleventh season of the SCCA Mazda MX-5 Cup. Now a 12-race series, the MX-5 Cup attracts many of pro racing's top

up-and-comers. It's a true test of talent and technique in which drivers compete in identically prepped MX-5s on many of America's legendary racecourses, including Mazda Raceway Laguna Seca.

Bottom line: The best streetcars make the best racecars. And the MX-5 has been—and still is—the most road-raced¹ of them all.

¹Based on Sports Car Club of America racing data.



YOU DON'T BECOME THE WORLD'S BEST-SELLING ROADSTER BY SETTTLING FOR THE STATUS QUO.

In 1989, Mazda debuted the MX-5 Miata. A quarter of a century, and one million worldwide owners later, the MX-5 continues to define—and redefine—what a roadster is meant to be.

Unwavering, uncompromising and committed to true sports car authenticity, the MX-5 has always been—and will always be—the track-proven real deal.

Nimble and near perfectly balanced, the MX-5 is an automotive icon and an engineering marvel that's built to dominate the open road, master every curve and effortlessly transform instinct into action. But to truly understand why it's the best-selling roadster of all time, you need to be in the driver's seat.

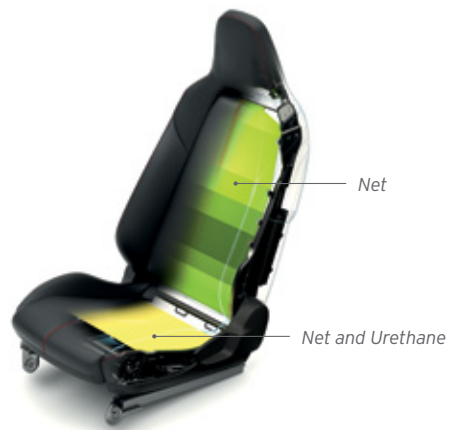

^
SEATS

Heated leather-trimmed bucket seats with three comfort settings in Grand Touring models are meticulously designed to conform to your every curve and adjust to your specific driving position.

To reduce vibration and improve holding capabilities of the driver, even in corners, the MX-5 seatbacks and cushions were designed with lighter netting materials. The best seat in the house just got more comfortable.



Mazda MX-5 Miata Grand Touring interior shown in Sport Tan leather



A CAR SHOULD BE AN EXTENSION OF YOUR BODY. DRIVING SHOULD BE AN EXTENSION OF YOUR SOUL.

The concept of *jinba ittai*, or “rider and horse as one,” is the inspiration for the MX-5. That a horse and its rider communicate by being instinctively in tune with each other—achieving effortless communication. The MX-5 is a car so precisely tuned, it isn’t complete until one variable enters—you, the driver.

To complete that same communication behind the wheel of an MX-5, Mazda engineers used multiple electromyograms and G sensors to analyze a driver’s complete interaction with the vehicle. From determining the exact location of the shift lever, to which muscles and precisely how much effort would be needed to shift, every aspect of the drive is engineered to not just connect you with your MX-5, but make you one with it.

Is it possible to increase the cabin room without expanding the dimensions outside? Mazda engineers achieved this marvel by tilting the steering wheel 10mm, increasing the head clearance by 11mm and allowing for the seats to recline by an additional 2° from the previous generation. The MX-5’s interior environment is designed to the utmost of form and function because it’s this attention to detail that matters when someone six feet tall takes a seat behind the wheel.

WHO SAYS A TWO-SEATER SPORTS CAR CAN'T FIT EVERYTHING?

The MX-5 comes fully equipped with a wide array of amenities you wouldn't expect to find in a track-proven sports car. We've introduced our most advanced infotainment technology, MAZDA CONNECT™, into the Club and Grand Touring models. All easily accessible from the multifunction Commander control within minimal distance to keep you focused on driving.

The 7-inch full color touch screen display is your window to the world and helps avoid distractions from the road. Pairing your mobile device via Bluetooth® technology connects your MX-5 to streaming media, music and social content from Facebook and Twitter feeds. Let the factory-integrated Navigation System on Grand Touring models keep you on course with voice-guided commands and advanced lane guidance. Even beyond just making and receiving hands-free calls from steering wheel mounted controls, the SMS Text Message Audio Delivery and Reply lets you stay connected and focused.

AVAILABLE AMENITIES

Navigation System with 3D interactive map / Advanced Keyless Entry System / Automatic Climate Control



Mazda MX-5 Miata Grand Touring interior shown in black leather



50mm wide range speakers

YOUR OWN PRIVATE AMPHITHEATER.

The top is dropped. The sun is glistening. Your cares may be going out the top, but your tunes shouldn't go along with them. In Club and Grand Touring models, the Bose® Premium Sound system creates an individual sonic experience. With 9 speakers, including two 50mm UltraNearfield™ speakers positioned in each of the MX-5's headrests, sound is as clear as day. From bass to treble, audiophiles can enjoy pure sound quality from their MP3s through dual USB audio inputs jacks. Only the roar of the MX-5's engine will penetrate the cabin thanks to the Bose® AudioPilot® 2 Noise Compensation Technology. Now unwanted noise is left where it belongs—outside.



SiriusXM Satellite Radio² / HD Radio™ / AM/FM/CD/MP3-compatible audio system / 2 USB Audio Inputs / Pandora® / Aha™ / Stitcher™



¹Don't drive while distracted. Even with voice commands, only use MAZDA CONNECT™/other devices when safe. Some features may be locked out while the vehicle is in motion. Not all features are compatible with all phones. Message and data rates may apply.

²SiriusXM Satellite Radio reception requires a subscription and Mazda satellite radio. See full disclaimer in Specifications.

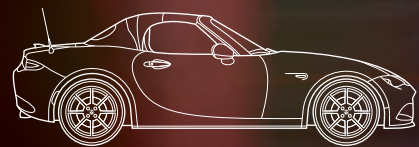
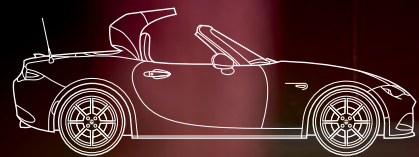
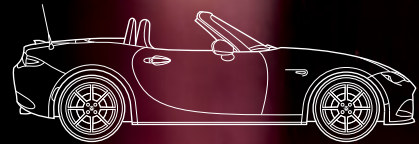

RETRACTABLE ROOF

In a matter of seconds, the MX-5's iconic soft top can be unlocked and dropped for pure driving enjoyment in one simple, intuitive and ergonomic step. Without having to leave the driver's seat, the release is quick, smooth and effortless—and you only need one hand. Should the sky suddenly decide to change, taking cover quickly is easy, thanks to the soft top's reduced weight and integrated "assist spring" mechanism. Because being comfortable in all weather matters.



WE BUILT THE CAR. FANS BUILT THE CULTURE. THE MIATA COMMUNITY.

There are over 125 Mazda MX-5 Miata clubs across the United States. Day trips, rallies, road runs, overnight excursions, track days, tech sessions, car talks and motorsports events fill our calendars. In fact, on September 5-7, 2014, over 1,900 fans attended the 25th anniversary celebration at Mazda Raceway Laguna Seca. We are the Mazda devotees who have an unrelenting passion for driving the world's best-selling roadster. Because having bugs in the grille and our tops down on 32-degree mornings is how we measure a great day. Loyal fans, enthusiasts and collectors know it's a special community to belong to because like us, Driving Matters. Join the club.





LOVED BY DRIVERS AROUND THE WORLD.
NOW IT'S OFFICIAL.

With a million Mazda MX-5 Miatas produced over the years, we're proud to say that the 2016 model was named 2016 World Car of the Year and 2016 World Car Design of the Year. We're truly honored a car with such a rich driving history and iconic design was recognized for both categories in the same year. It's more proof that Driving Matters.



WINNER
2016 WORLD CAR AWARDS
WORLD CAR DESIGN OF THE YEAR



WINNER
2016 WORLD CAR AWARDS
WORLD CAR OF THE YEAR

MAZDA MX-5 MIATA COLORS

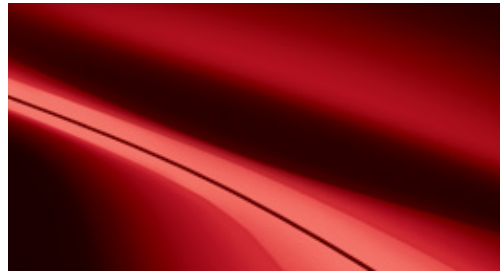

Soul Red Metallic¹



Meteor Gray Mica



Jet Black Mica

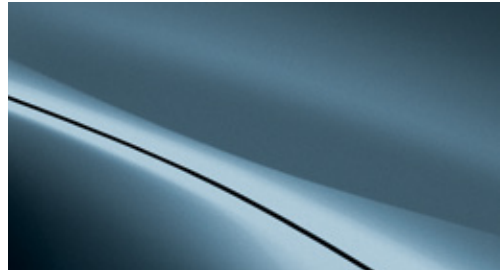

Blue Reflex Mica



Ceramic Metallic



Arctic White



Crystal White Pearl Mica¹
¹Extra cost option.

MAZDA MX-5 MIATA UPHOLSTERY

SPORT

Black Cloth

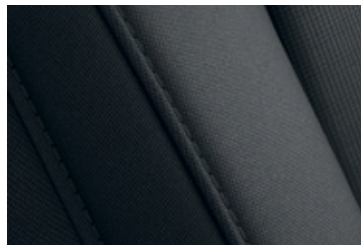

CLUB

Black Cloth with Red Accent Stitching

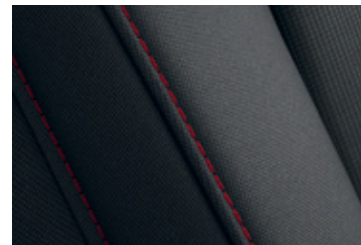

GRAND TOURING

Black Leather with Red Accent Stitching

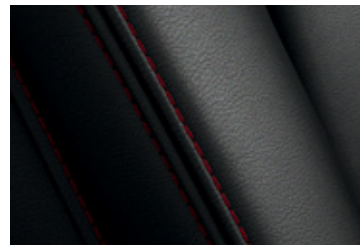

Sport Tan Leather



MAZDA MX-5 MIATA WHEELS



16-inch Alloy Sport



17-inch Alloy Club



17-inch Alloy Grand Touring

CAN A FEW BLINKING LIGHTS GIVE YOU PEACE OF MIND?

Because feeling safe and having confidence behind the wheel of a convertible sports car matters, our i-ACTIVSENSE[®] suite of safety technologies provides the ultimate sense of security and driving confidence. Knowing that there's advanced safety features active while you're enjoying the drive means less distraction. Being alerted to a hazard before it's an issue helps avoid collisions in the first place, or even lessen their impact. i-ACTIVSENSE is there when you need it, without encumbering your driving experience.

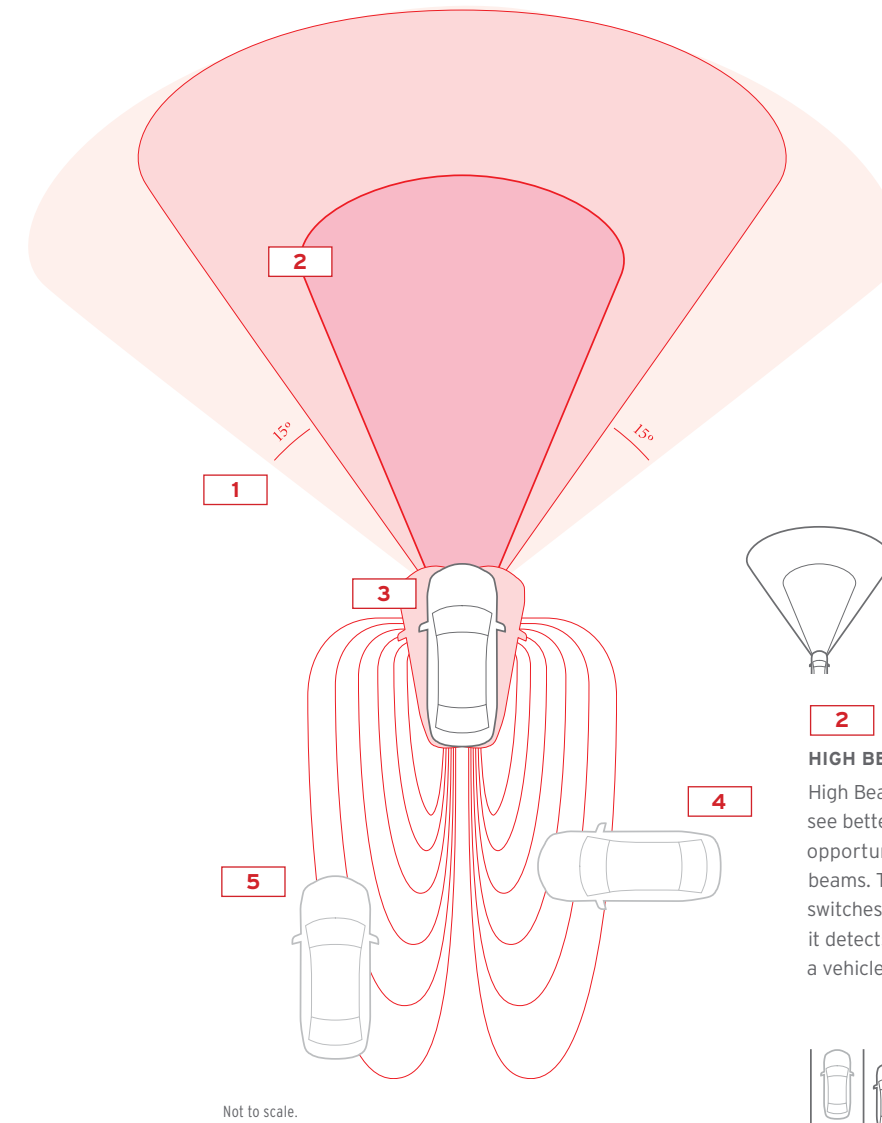

Not to scale.

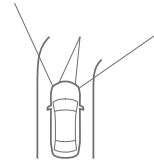

1

LED HEADLIGHTS WITH ADAPTIVE FRONT-LIGHTING SYSTEM

The MX-5 offers standard LED headlights. Grand Touring models also feature Mazda's Adaptive Front-lighting System, which is designed to help you see around corners at night—literally. As you turn into a corner, the headlights pivot up to 15 degrees in the direction of your turn, improving visibility and allowing you to spot potential hazards and dangers ahead.

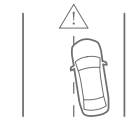

3

LANE DEPARTURE WARNING SYSTEM²

This system gives audible and visual warnings when the vehicle is about to unintentionally depart from its lane at a speed of 41 mph or higher.

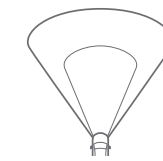

2

HIGH BEAM CONTROL

High Beam Control helps the driver see better at night by maximizing opportunities to use the high beams. The system automatically switches to the low beams when it detects oncoming traffic and/or a vehicle ahead.

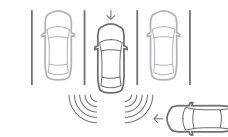

4

REAR CROSS TRAFFIC ALERT¹

When backing up, this system detects a vehicle approaching from the side and promptly alerts the driver with an audible warning, as well as a visual warning in both side mirrors.



5

BLIND SPOT MONITORING¹

Radar sensors detect objects in your left or right blind spots and then alert you with a warning light that appears in the corresponding side mirror. If you signal a lane change while an object is there, the light blinks and a cabin warning chime sounds.

i-ACTIVSENSE

¹Always check your mirrors. Be aware of the traffic around you. There are limitations to the range and detection of the system. Please see your Owner's Manual for further details. ²Lane Departure Warning System is not a substitute for safe and attentive driving. There are limitations to the range and detection of the system. Please see your Owner's Manual for further details.

MAZDA MX-5 MIATA SPORT

16-inch aluminum alloy wheels with 195/50 R16 high-performance tires
LED headlights
Daytime running lights
Black-painted power side mirrors
Black cloth convertible top with glass rear window
Air conditioning
Cloth sport seats
Power door locks
Mazda advanced keyless entry system (AT models)
Power windows with driver's and passenger's one-touch-down feature

Leather-wrapped steering wheel with steering wheel-mounted audio and cruise controls
Leather-wrapped shift knob
Tilting steering column
AM/FM/CD/MP3-compatible audio system with 6 speakers including driver's headrest speakers
Bluetooth® hands-free phone and audio streaming
USB audio input port
Mesh aero board
Trip computer
Dual front air bags and side-impact air bags¹



WHEEL
16-inch Alloy

BLACK CLOTH



EXTERIOR COLORS

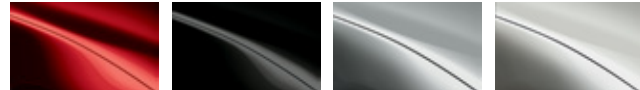

MAZDA MX-5 MIATA CLUB *Includes the following features in addition to or in place of Mazda MX-5 Miata Sport*

Exclusive 17-inch aluminum alloy wheels with Dark Gunmetal finish
205/45 R17 high-performance tires
LED daytime running lights
Black-painted power side mirrors
Front shock tower brace (MT models)
Sport-tuned suspension with Bilstein® shock absorbers and limited-slip differential (MT models)
Painted black front air dam and rear lip spoiler
Blind Spot Monitoring²
Rear Cross Traffic Alert²
Black cloth seats with red stitching

Glossy black seat back bar trim
MAZDA CONNECT™ Infotainment system³ with:
– 7-inch full-color touch-screen display
– Multifunction Commander control
– HD Radio™
– Infotainment system voice command
– Aha™ internet radio integration
– Pandora® internet radio integration
– Stitcher™ internet radio integration
– Radio Broadcast Data System program information
– SMS text message audio delivery and reply
Dual USB audio input ports
SiriusXM Satellite Radio with 4-month trial subscription to the Sirius All Access package⁴

Bose® Surround Sound audio system with AudioPilot® 2
9 speakers including driver's and passenger's headrest-mounted speakers
Available Brembo®/BBS Package:
Includes Brembo front ventilated disc brakes with red calipers, BBS forged 17-inch alloy wheels with Dark Gunmetal finish and black painted side sill extensions and rear bumper skirt (MT models only)



WHEEL
17-inch Alloy with Dark Gunmetal finish

BLACK CLOTH WITH RED ACCENT STITCHING



EXTERIOR COLORS



MAZDA MX-5 MIATA GRAND TOURING *Includes the following features in addition to or in place of Mazda MX-5 Miata Sport*

17-inch aluminum alloy wheels with Dark Silver finish
205/45 R17 high-performance tires
Auto on/off headlights
Adaptive Front-lighting System
High Beam Control
LED daytime running lights
Leather-trimmed sport seats
Heated seats with three settings
Glossy black seat back bar trim

MAZDA CONNECT™ Infotainment system³ with:
– 7-inch full-color touch-screen display
– Multifunction Commander control
– HD Radio™
– Infotainment system voice command
– Aha™ internet radio integration
– Pandora® internet radio integration
– Stitcher™ internet radio integration
– Radio Broadcast Data System program information
– SMS text message audio delivery and reply
Dual USB audio input ports
SiriusXM Satellite Radio with 4-month trial subscription to the Sirius All Access package⁴

Bose® Surround Sound audio system with AudioPilot® 2
9 speakers including driver's and passenger's headrest-mounted speakers
Leather-wrapped shift knob
Blind Spot Monitoring²
Rear Cross Traffic Alert²
Land Departure Warning System⁵
Dual front air bags and side-impact air bags¹
Auto-dimming rearview mirror with HomeLink®

EXTERIOR COLORS



BLACK LEATHER WITH RED ACCENT STITCHING

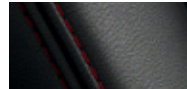

EXTERIOR COLORS

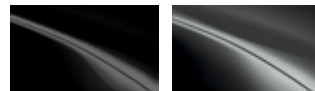

SPORT TAN LEATHER

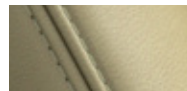

WHEEL
17-inch Alloy with Dark Silver finish

MAZDA MX-5 MIATA SPECIFICATIONS

ENGINE & TRANSMISSION

SKYACTIV®-G 2.0L DOHC 16-valve 4-cylinder engine with variable valve timing
Aluminum alloy engine block and cylinder head
SKYACTIV-MT 6-speed manual transmission with short-throw shifter
Available 6-speed Sport automatic transmission with paddle shifters

MECHANICAL

Aluminum Power Plant Frame
Rack-and-pinion steering with double pinion electric power assist
Power-assisted 4-wheel disc brakes
Anti-lock Brake System (ABS) with Electronic Brakeforce Distribution
Double-wishbone front suspension with aluminum control arms
Independent multilink rear suspension with aluminum bearing support
Front and rear stabilizer bars; gas-charged shock absorbers
Front shock tower brace (Club MT model)
Dynamic Stability Control⁶
Traction Control System

EXTERIOR DIMENSIONS

Wheelbase/overall length (in) 90.9 / 154.1
Overall width (in) 68.3
Overall height (in, 16" wheels/17" wheels) 48.6 / 48.8
Track (in, front/rear) 58.9 / 59.2

CURB WEIGHTS (LB)

6-speed manual 2,332
6-speed Sport automatic 2,381

INTERIOR DIMENSIONS

Head/leg/shoulder (in) 37.4 / 43.1 / 52.2

ENGINE

Engine size and type SKYACTIV-G 2.0L 4-cylinder DOHC gasoline engine
Valve gear DOHC 16-valve with variable intake-valve timing
Horsepower, SAE net 155 hp @ 6,000 rpm
Torque, SAE net (lb-ft) 148 lb-ft @ 4,600 rpm
Redline (rpm) 6,800
Bore and stroke (in) 3.29 x 3.59
Compression ratio 13.0:1
Ignition system Distributorless electronic
Fuel system Electronically-controlled fuel injection
Recommended fuel Premium unleaded gasoline
Overall steering ratio 15.5:1
Steering wheel turns, lock-to-lock 2.7
Turning circle, curb-to-curb (ft) 30.8
Brakes 11-inch ventilated front discs;
11-inch solid rear discs

TRANSMISSION RATIOS

	6-SPEED MANUAL	6-SPEED AUTOMATIC
1ST GEAR	5.087	3.538
2ND GEAR	2.991	2.060
3RD GEAR	2.035	1.404
4TH GEAR	1.594	1.000
5TH GEAR	1.286	0.713
6TH GEAR	1.000	0.582
FINAL DRIVE	2.866	3.454

CAPACITIES

Cargo volume (cu ft) 4.6
Fuel capacity (U.S. gallons) 11.9

FUEL ECONOMY (EPA-ESTIMATED MPG, CITY / HWY)

SKYACTIV-MT 6-speed manual 26 / 33⁷
6-speed Sport automatic 26 / 35⁷

WE'RE COMMITTED TO OUR DRIVERS.

Every new 2017 Mazda MX-5 Miata is protected by a:

- 3-year/36,000-mile¹ New Vehicle Limited Warranty
- 3-year/36,000-mile¹ 24/7 Emergency Roadside Assistance Program
- 5-year/60,000-mile¹ Limited Powertrain Warranty
- 5-year/unlimited-mileage Warranty Against Body Rust-Through (Anti-Perforation Limited Warranty)

¹Whichever comes first



MAZDA EXTENDED CONFIDENCE

Even after your vehicle warranty has expired, Mazda Extended Confidence provides nearly all the same parts and components covered under your New Vehicle Limited Warranty. Accepted nationwide and utilizing only Genuine Mazda Parts (where available), Mazda Extended Confidence gives you peace of mind for miles beyond your expectations.

FOR DETAILS, PLEASE SEE YOUR MAZDA DEALER, VISIT MAZDAUSA.COM OR CALL TOLL-FREE (800) 639-1000.

FINANCING WITHOUT THE FUSS.



MAZDA CAPITAL SERVICES

Whether you're buying or leasing a new Mazda, Certified Pre-Owned Mazda or a used vehicle, Mazda Capital Services² can help make the financing process more convenient and satisfying. One of the largest auto lenders in America, Mazda Capital Services is known for first-class customer service, a wide range of financing options and highly competitive rates.

To find out which purchase or lease plan is right for you, talk with your Mazda Dealer or visit MazdaUSA.com.

²The trademark "Mazda Capital Services," as well as the Mazda and Mazda Capital Services logos, are owned by Mazda Motor Corporation or its affiliates and are licensed to JPMorgan Chase Bank, N.A. ("Chase"). Retail/loan and lease accounts are owned by Chase.

i-ACTIV AWD, SKYACTIV and i-ACTIVSENSE are registered trademarks of Mazda Motor Corporation. Driving Matters and Mazda Drive for Good are registered trademarks of Mazda Motor of America, Inc. iPhone is a registered trademark of Apple Inc. Android is a registered trademark of Google Inc. Bluetooth is a registered trademark of Bluetooth SIG, Inc. HomeLink is a registered trademark of Gentex Corporation. All other marks, logos, and product names are the property of Mazda Motor Corporation, its affiliates, or are the property of their respective owners.

³Always wear your seat belt and ensure that the passenger air bag deactivation light is illuminated when using a child- or infant-restraint system. Please see your owner's manual for details. ⁴Always check your mirrors. Be aware of the traffic around you. There are limitations to the range and detection of the system. Please see your Owner's Manual for further details. ⁵Don't drive while distracted. Even with voice commands, only use MAZDA CONNECT™/other devices when safe. Some features may be locked out while the vehicle is in motion. Not all features are compatible with all phones. Message and data rates may apply. ⁶SiriusXM Satellite Radio reception requires a subscription and Mazda satellite radio. Subscriptions to SiriusXM services are sold by SiriusXM after a 4-month trial subscription to the SiriusXM All Access package expires and are continuous until you call SiriusXM at 1-866-635-2349 to cancel. See SiriusXM Customer Agreement for complete terms at www.siriusxm.com. Sirius satellite service available only to those at least 18 and older in the 48 contiguous USA, D.C. and P.R. (with coverage limitations). Sirius, XM and all related marks and logos are trademarks of Sirius XM Radio Inc. ⁷Land Departure Warning System is not a substitute for safe and attentive driving. There are limitations to the range and detection of the system. Please see your Owner's Manual for further details. ⁸Dynamic Stability Control (DSC) is an electronic system designed to help the driver maintain control under adverse conditions. It is not a substitute for safe driving practices. Factors including speed, road conditions and driver steering input can all affect whether DSC will be effective in preventing loss of control. Please see your Owner's Manual for further details. ⁹EPA-estimated mileage. Actual results will vary.



DRIVING MATTERS MOST WHEN YOU'RE DRIVING FOR GOOD.

To Mazda, there's only one thing that means as much as driving: giving back.

The Mazda Drive for Good® event is our annual charitable program that allows us to give back to those in need. But we don't do this alone. For every purchase of a Mazda, drivers like you have helped us raise millions of dollars for both national and local charities. But what's even more significant is that for every test drive taken during the event, we pledge one hour of community service to local worthy causes across the country. And last year, we pledged more than 72,000 hours of volunteer time to those who needed it most. All thanks to people like you who simply took a test drive.

Our Mazda Dealers have a long history of giving back both time and money to their communities. And their efforts truly define our Mazda values. Mazda Drive for Good is just one of the many charitable programs that has allowed Mazda to donate to worthy causes across the United States since 1992.

Because we believe giving back matters.



WE KNOW YOUR FIRST IMPRESSION OF MAZDA STARTS WITH US, YOUR MAZDA DEALER.

It's a responsibility we don't take lightly. It's why we work hard every day to make sure your customer service experience exceeds your expectations, in every way. From the factory to your first test drive, and to every drive you'll ever make in a Mazda, we're here because to us, Driving Matters.





MazdaUSA.com



© 2016 Mazda Motor of America, Inc. • 7755 Irvine Center Drive, Irvine, CA 92618 • (800) 639-1000 • Correct at time of printing • Printed in U.S.A. 7/16 (15k)
Part No. 17MX5HYP

PRODUCT CHANGES AND OPTIONS AVAILABILITY: Following publication of this brochure, certain changes in standard equipment, options, prices and the like or product delays may have occurred which would not be included in these pages. Your Mazda Dealer is your best source for up-to-date information. Mazda reserves the right to change product specifications at any time without incurring obligations. Options shown or described in this brochure are available at extra cost and may be offered only in combination with other options or subject to additional ordering requirements or limitations.