

1977 MERCURY
COUGGAR







Here, for '77, is a bold
new symbol of driving:
Mercury Cougar XR-7—a totally new look!

The 1977 Mercury Cougar XR-7. Bold. Aggressive. New. With stunning looks, sporty lines and a sweeping list of exciting standard appointments. More of a Cougar than we've ever unleashed before. A car so unique that it has inspired the Cat Set—that loyal group of Cougar owners who will settle for nothing less than the superb craftsmanship and styling inherent in the Cougar XR-7 and its six new running mates. Choose from 2 new sedans, 2 new hardtops and 2 new wagons. All Cougar at heart. These cats deliver new comfort and convenience with Cougar's own brand of driving excitement. And they're Ride-Engineered by Lincoln-Mercury. See all the new Cougars paraded in the pages of this brochure. Then put your favorite Mercury Cougar through its paces at the sign of the cat.

RIDE-ENGINEERED by **LINCOLN
MERCURY**

Cougar XR-7 with Decor option.



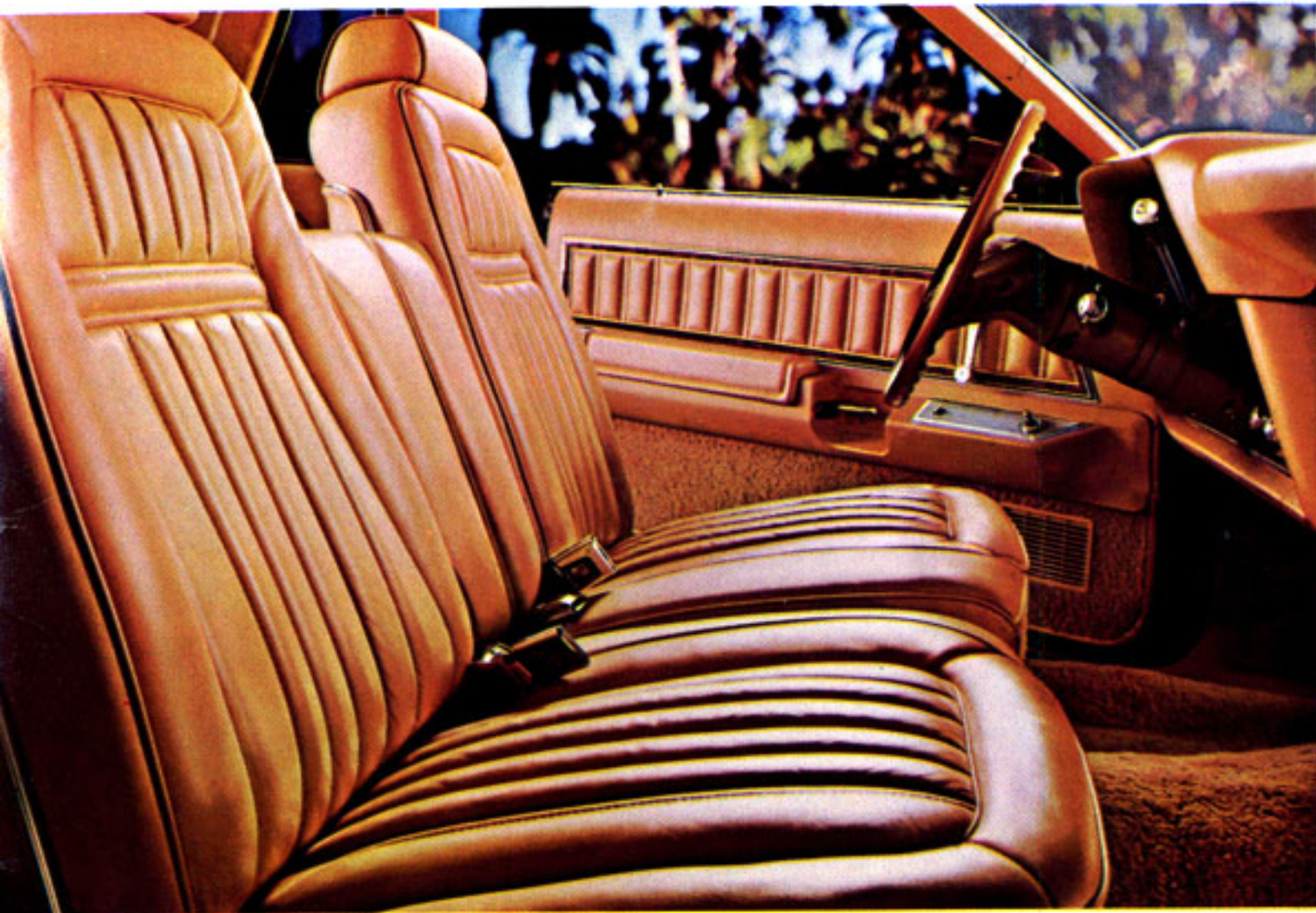

New action for the Cat Set. And Ride-Engineered by Lincoln-Mercury. All yours in the Cougar XR-7!

Is XR-7 a sporty road machine? Or a glamorous luxury car? Actually, it's a little of both. And unique in a number of exciting ways. There's never been a Cougar so deeply elegant or styled with more sophisticated flair. Cougar XR-7 is also famous for the abundance of personal touches in its thoughtfully conceived interior. Richly spacious and quiet. Consideration for your comfort and convenience is everywhere. If this isn't enough, you can go even further in personalizing your own XR-7 from the broad choice of options on page 16. Choose, for example, the optional Decor Group. It lets you select either of the two interior designs shown at the left. Above are shown the Twin Comfort Lounge Seats in chamois colored leather with vinyl, also available in dove grey, dark red, medium blue, jade, saddle or saddle/white, and white with your choice of color coordinated components. Shown below is the Decor Group interior with all-vinyl bucket seats and console in white-with-lipstick. Decor groups are also available with cloth and vinyl in all the same color choices above except saddle/white, and white with colored components.

Mercury Cougar XR-7 and, foreground, Mercury Cougar XR-7 with Tu-Tone Paint Option



Cougar XR-7: a car like nobody else's car. Again!

Cougar XR-7 is more than ever a one-of-a-kind car. For '77, Cougar XR-7 remains a truly unique personal car. Coveted for its uncompromised luxury and comfort. If you're an admirer of spaciousness and deep comfort—if you think a car like Cougar should offer such amenities as optional full instrumentation and the enviable list of standard features Cougar is noted for, you'll be glad to know here is one personal-size car that's on your side.

Among other things, try it on for size! Try it on too, for its inner meanings. Example: the XR-7's engine-turned sports instrumentation group shown upper left or the uniquely louvered opera window, upper right. The handsome tailored look of the XR-7 standard Flight Bench Seat interior is shown below in dove grey all-vinyl (also available in cloth and vinyl) and in dark red, medium blue, jade, chamois or saddle.

Cougar XR-7 standard features include: 302-2V V8 engine • Select-Shift automatic transmission • Power brakes • Power steering • DuraSpark Ignition system • HR78x15 steel-belted radial tires and 15-inch wheels • Lincoln-Mercury Ride-Engineered suspension system • XR-7 sound-hushing package • Landau vinyl roof • Louvered opera windows • Dual headlamps • Luxury Cougar wheel covers • Deluxe steering wheel • Electric clock • Walnut instrument panel appliques • Cut-pile carpeting • Day/night rearview mirror • Concealed windshield wipers • Dual-note horn • Glove box with lock • Inside hood release • Full complement of Ford Motor Company Lifeguard Design safety features • Other equipment shown optional.

Sports Instrumentation Group

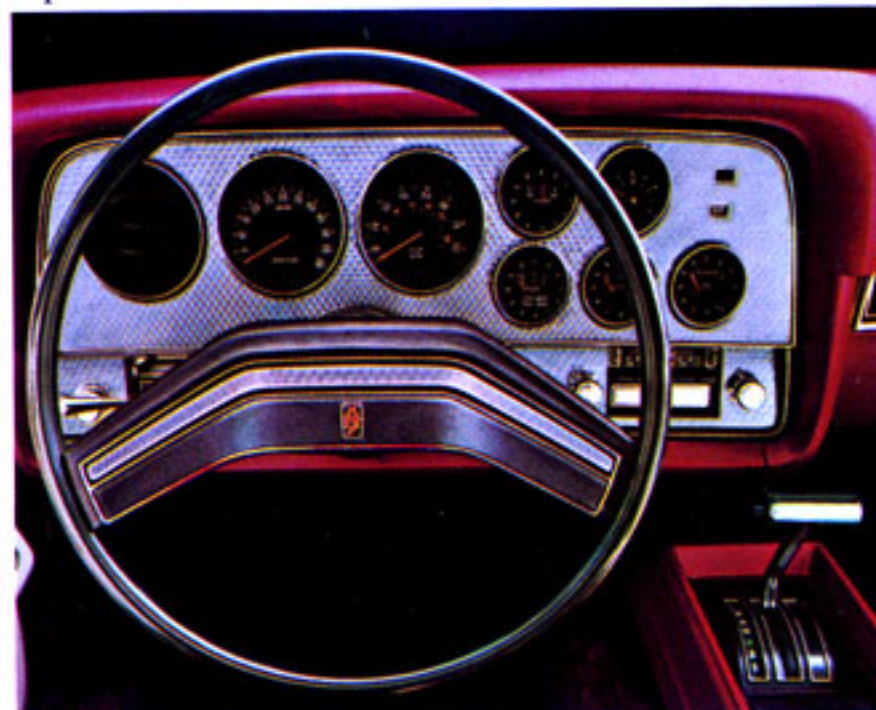

Louvered Opera Window

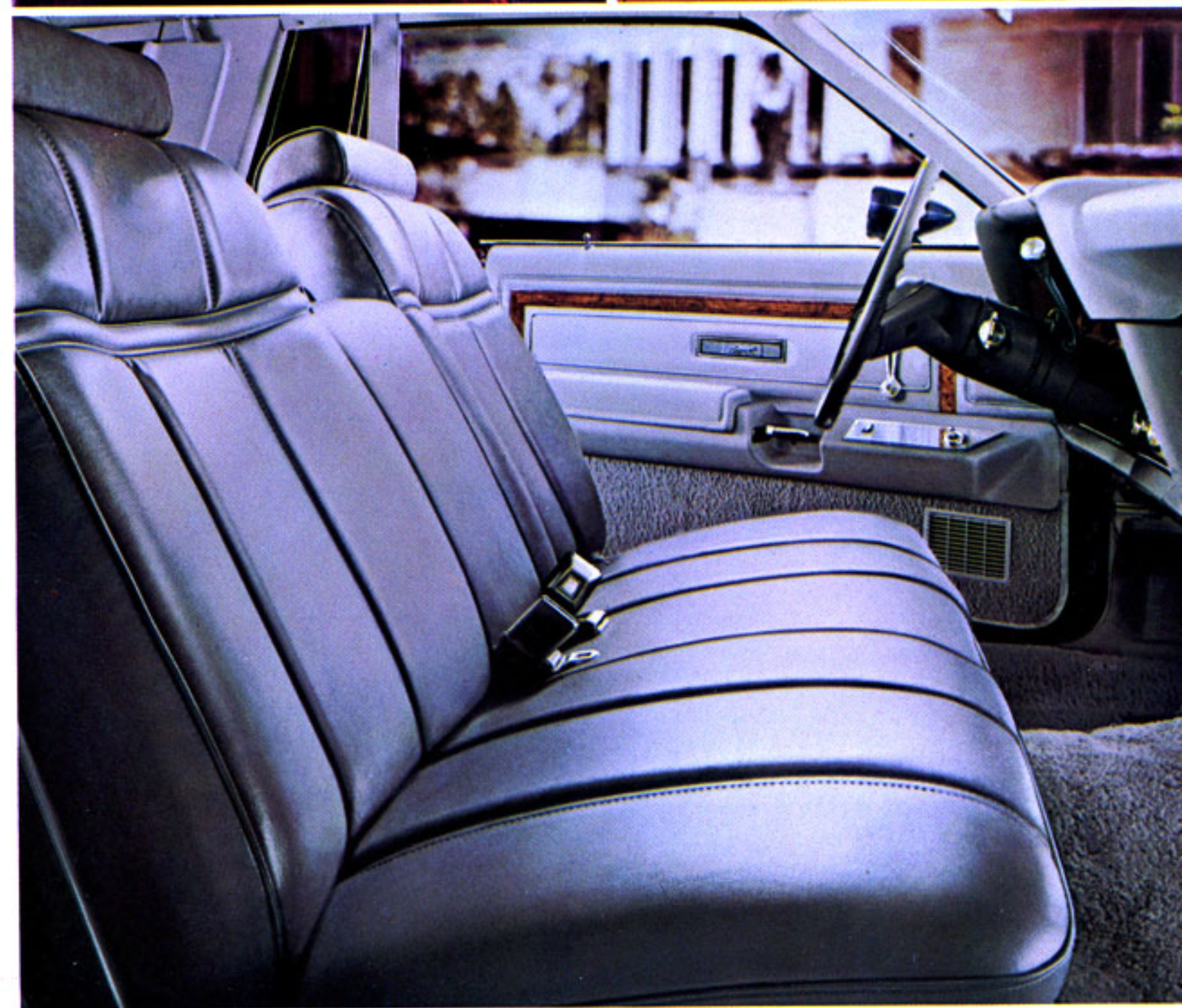
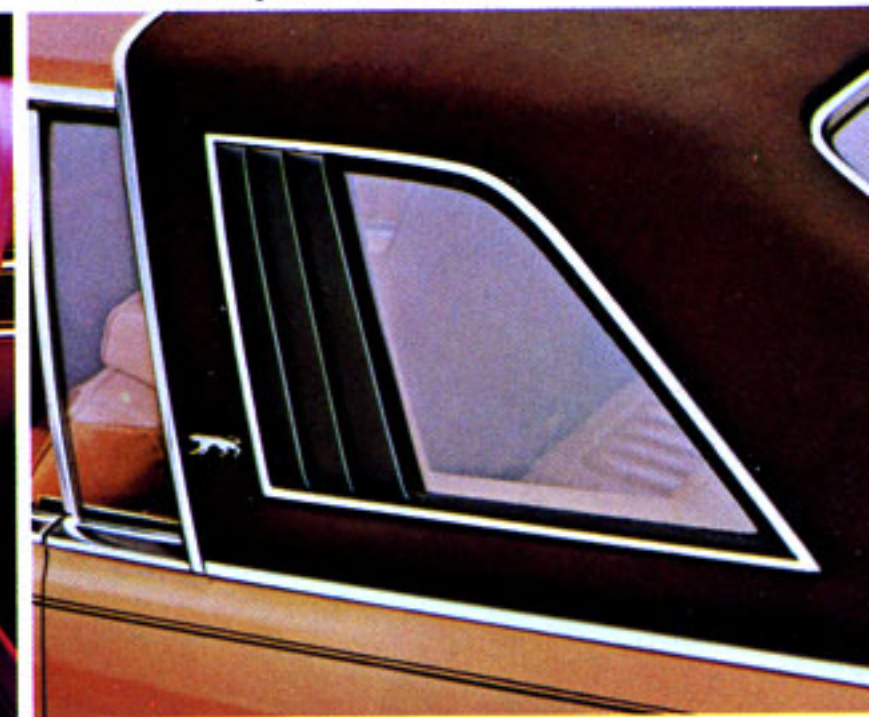

Mercury Cougar Brougham 2-Door; Mercury Cougar Villager Wagon; Mercury Cougar Brougham 4-Door.

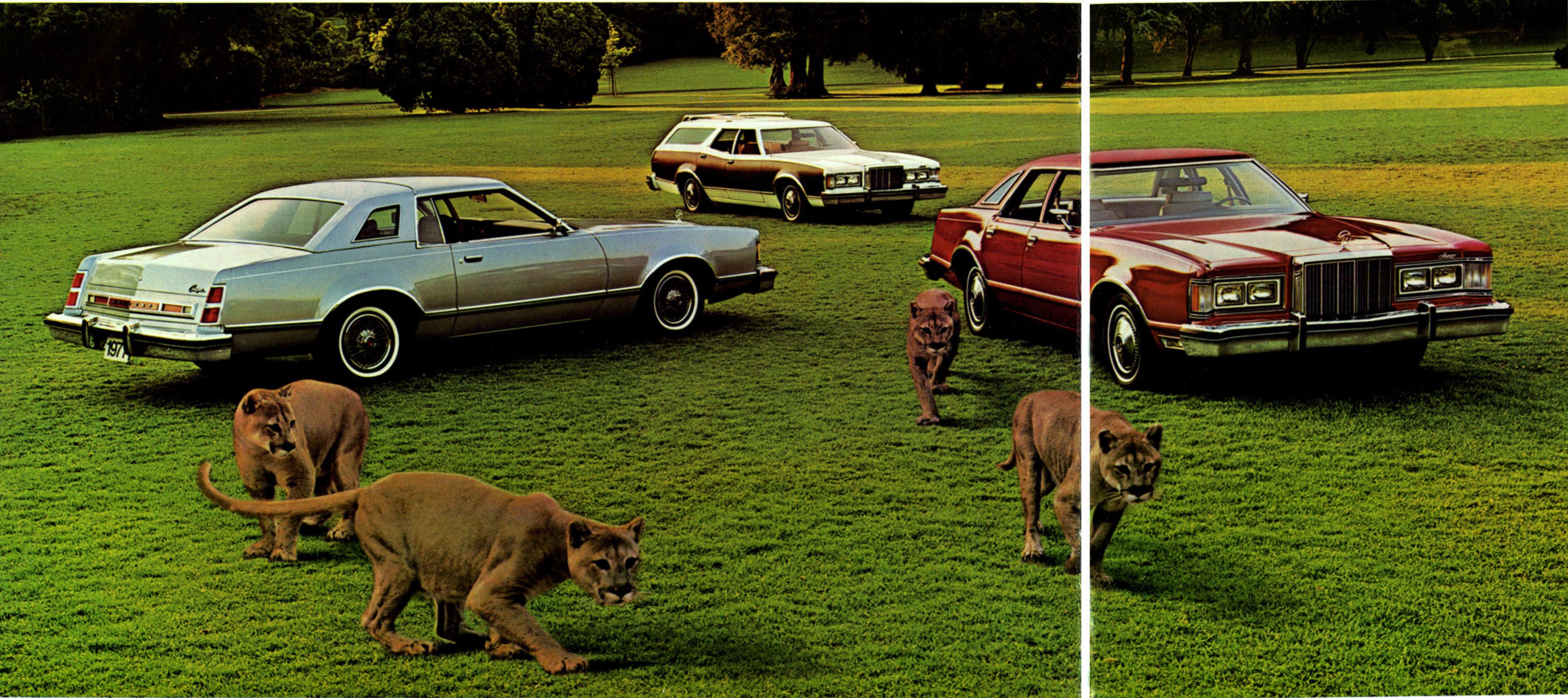

And now, more new action for the Cat Set in a whole new breed of Cougars.

If ever a time was to be destined as the "year of the cat," '77 must surely be it! This year XR-7 unleashes fresh, youthful excitement in six new Cougar running mates. The Cougar Brougham, 2-door and 4-door; the Cougar, 2-door and 4-door; and two new wagons. Glamorous family cars. Bold in their newborn styling. Exciting in their sureness on the highway. In the precisely honed smoothness of their ride. Elegant in the way they blend interior roominess with high decor and meticulous tailoring. The look and the excitement are new. But you'll find in these new Cougars a proud Mercury heritage of careful research and development. Ride-Engineered by Lincoln-Mercury . . . a detailed and attentive concern for engineered excellence in the Cougar ride. New excitement for the Cat Set: Cougar XR-7's thoroughbred pack of running mates. Drive one. Celebrate the "year of the cat!"

Mercury Cougar Brougham 4-Door



Cougar Brougham: Ride-Engineered by Lincoln-Mercury. You'll know it's an elegant offspring of the renowned XR-7 the moment you experience its sophisticated road manners.

It doesn't take a purist to recognize the kinship of this excitingly styled car to its running mate, the Cougar XR-7. If its youthful looks and bold stance don't tell you, its ride most certainly will. You'll find both 4-door (shown left) and 2-door offer generous room for relaxing as you drive. Quiet. Smooth. Responsive to your bidding. Just a few moments at the wheel, or as a passenger, and you, too, will become a Mercury enthusiast! Cougar Brougham interiors have been fashioned to inspire you with their contemporary freshness and mood. Above at the right is illustrated the standard Flight Bench Seat interior in optional saddle vinyl (cloth-and-vinyl standard). Below right is shown the Brougham Decor option with Twin Comfort Lounge Seats in medium blue cloth-and-vinyl (all-vinyl optional), with reclinable passenger seat, luxury steering wheel, deluxe carpeting and other added luxury touches. Both interiors are available in dove grey, dark red, medium blue, jade, chamois or saddle. Twin Comfort Lounge Seats, in all-vinyl saddle/white, are also available.



Cougar Brougham standard features include: 302-2V V-8 engine • Select-Shift automatic transmission • Power brakes • Power steering • DuraSpark Ignition system • HR78x14 steel-belted radials • Ride-Engineered suspension system • Deluxe sound package • Dual headlamps • Deluxe wheel covers • Deluxe steering wheel • Electric clock • Cut-pile carpeting • 12 inch day/night rearview mirror • Concealed windshield wipers • Inside hood release • Full complement Ford Motor Company Lifeguard Design safety features • Other equipment shown optional.

Mercury Cougar 2-Door



Mercury Cougar! A beautiful idea for families who would like to enter the exciting world of the Cat Set without a setback in their budget.

This is the year of the cat, make no mistake about it! And if your family is ready for the fun that this new kind of Cougar has in store, maybe it's the year of *your* cat!

It's our Cougar XR-7's most affordable running mate, a real show-winner on its own. Choose the 2-door hard-top or the 4-door sedan. Like all other Cougar models, it can be made personally yours with a long list of options (see back page) ranging from sports instrumentation to a new AM/FM/MPX radio with Quadrasonic-8 tape player. And of course this Cougar's wonderful ride is made even

more so by the family-room comfort of its generously dimensioned interior. Standard Bench Seat decor in jade cloth-and-vinyl is shown at the top right. It is also available in dove grey, dark red, medium blue, chamois or saddle. Illustrated below right is the optional bucket seat interior in saddle-with-white vinyl. Also available in the other colors mentioned above.

Cougar standard features include: 302-2V V-8 engine • Select-Shift automatic transmission • Power brakes • Power steering • Dura Spark Ignition system • HR78x14 steel-belted radials • Ride-Engineered suspension system • Deluxe sound package • Dual headlamps • 2-Spoke color-keyed steering wheel • Cut-pile carpeting • 12 inch day/night rearview mirror • Concealed windshield wipers • Inside hood release • Full complement Ford Motor Company Lifeguard Design safety features • Other equipment shown optional.

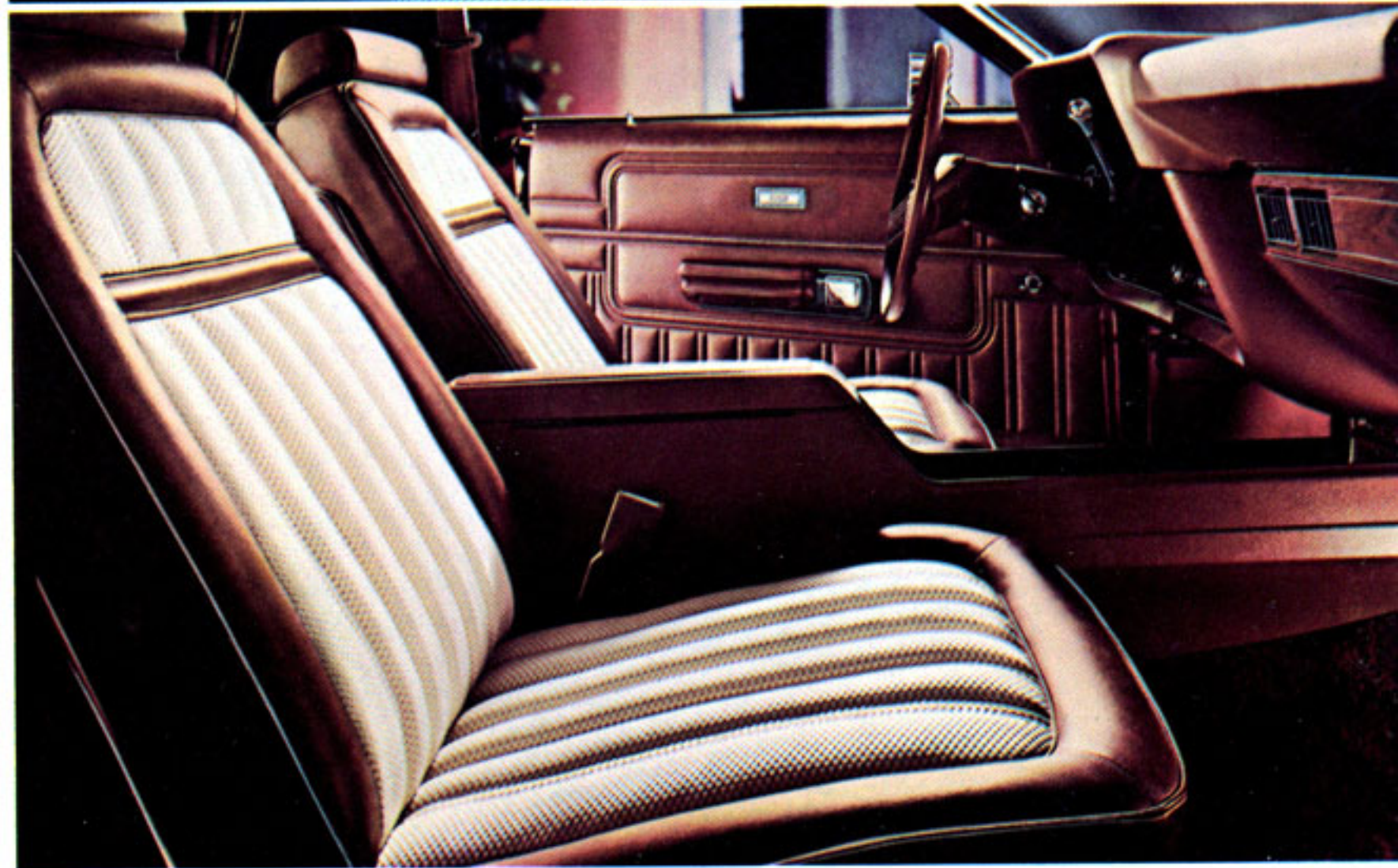
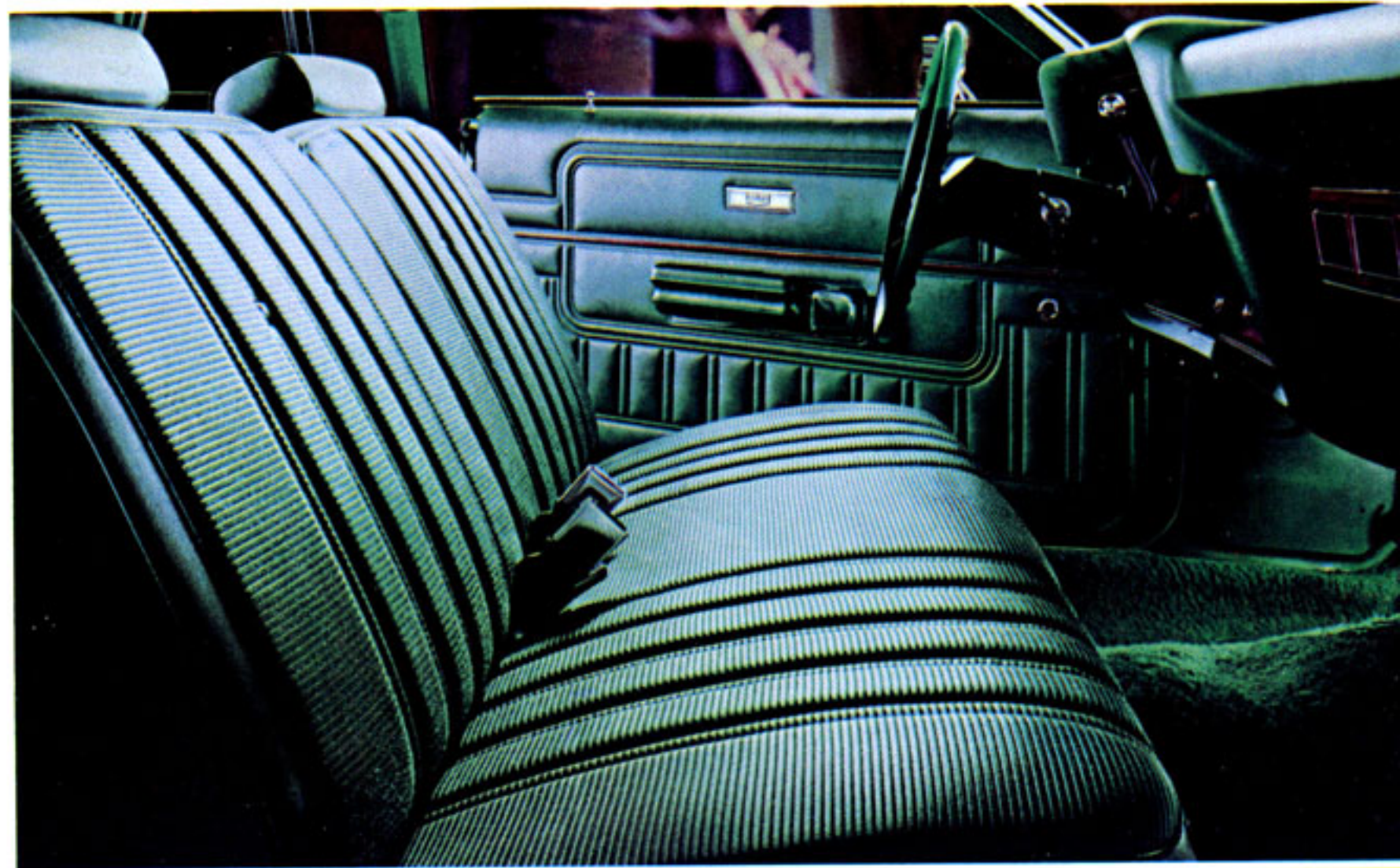

“Ride-Engineered by Lincoln-Mercury” — the sum total of all the engineering attributes you’ll find on these pages.

Our ride is known far and wide. It is the sum of a lot of things, large and small, that go to make up the total environment we call . . . Ride-Engineered by Lincoln-Mercury. Much of the riding comfort you’ll experience in your 1977 Cougar stems from its road-tuned suspension design, front and rear. In front, fully independent coil springs and shock absorbers cushion front wheel movements, soaking up the bumps. A link-type front stabilizer bar fights excessive sway and “lean” when cornering. The rear suspension is based on calibrated helical springs and hydraulic shock absorbers. Rubber bushings are used at all pivot points, front and rear, reducing vibration and road noise even further.

One good turn leads to another. Standard power steering on your 1977 Cougar gives you fingertip control and nearly effortless guidance. A flex coupling in the steering shaft helps isolate road jolts from reaching your hands at the wheel. Cougar’s wide stance also contributes to its sureness on the open road and through the winding turns.

Room at the top — and everywhere else. Cougar’s passenger compartment/wheelbase ratio retains generously dimensioned headroom, hiproom and legroom. The body is strong and rigid, working with a unique torque box frame to help keep road shocks, noise and vibration down.

A secret between you and the outside world. Cougar offers over 60 pounds of insulation in such major areas as roof, floor, fenders, roof pillars, cowl, dash, hood, luggage compartment — even behind the rear seat. A welcome addition to your sense of peaceful quiet as you drive. **Put a stop to all that.** Cougar’s power brakes (front disc,

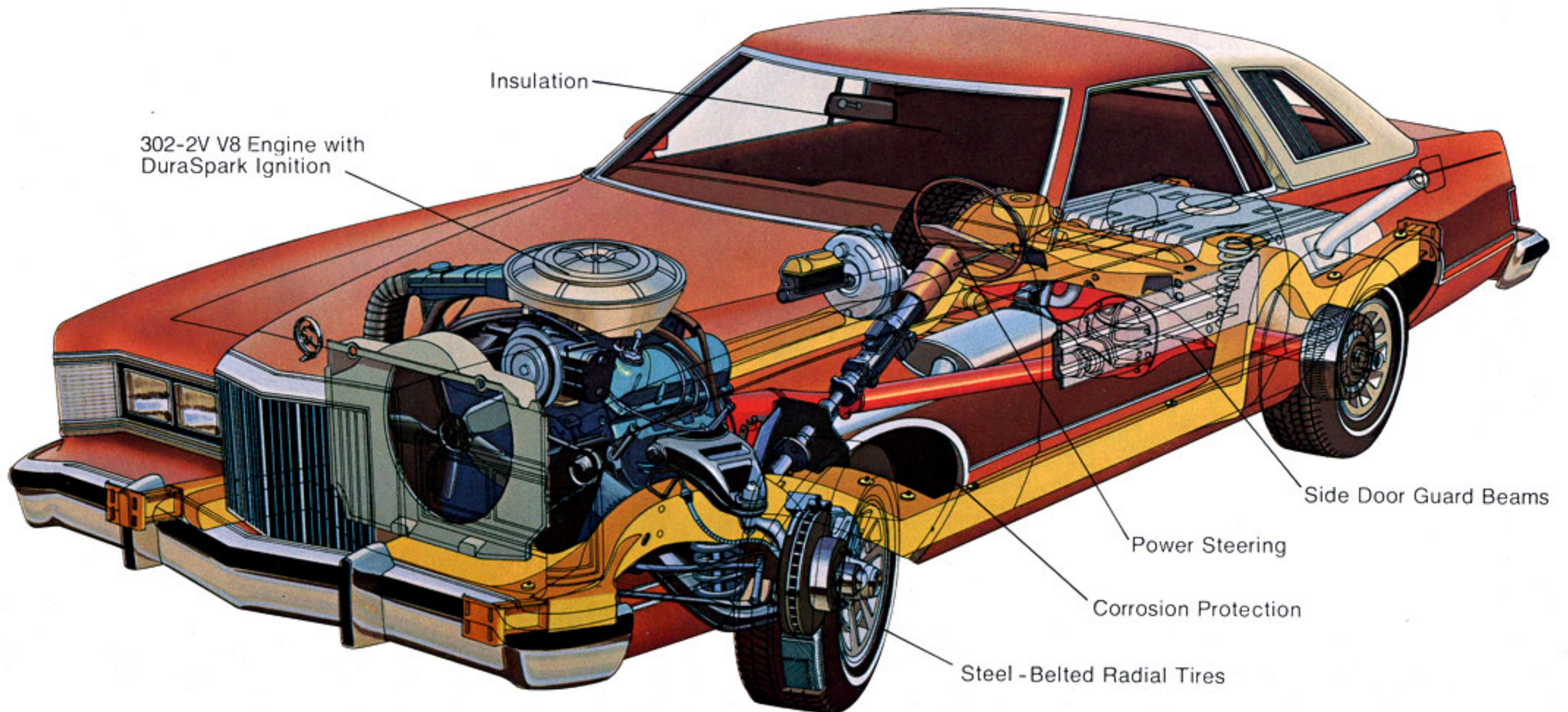

rear drum) put a vacuum power assist system at your command to afford positive stopping power.

Reduced maintenance, anyone? Since 1973, Mercury engineers have eliminated or extended the scheduled maintenance requirements of 30 items under normal driving conditions. Recommended spark plug change and engine tune-ups on most V8 engines, for example, have been extended to 22,500 miles. What's more, oil filter and oil change intervals on these engines have been extended by 50% over 1976 intervals, to every 7,500 miles for oil and every other time for filter. All 1977 Mercury engines are equipped with our new DuraSpark solid-state ignition system, which offers a substantially increased electrical voltage output over our 1976 system.

Corrosion protection expanded. In 1977, all Mercurys will feature expanded use of precoated steel to provide additional corrosion protection in several major body areas. Mercury Cougar will also feature use of a sealer on the underside of the rear wheelhouses and the continued use of sealers for protection in the lower areas most susceptible to corrosion.

Cougar puts it together. The "Mercury ride" is more than just a system of components. It is a considered concern for all the elements which make up the way a car rides and handles. This is what we mean when we say "Ride - Engineered by Lincoln-Mercury."

Cougar Dimensions

	2-door	4-door
Wheelbase	114.0"	118.0"
Length	215.5"	219.5"
Width	78.0"	78.0"
Headroom, front	37.3"	38.0"
Headroom, rear	36.3"	37.0"
Hiproom, front	58.8"	58.8"
Hiproom, rear	57.0"	57.0"
Legroom, front (maximum)	42.3"	42.3"
Legroom, rear (minimum)	32.8"	37.2"
Curb weight	4154.	4236.
Luggage Capacity (Cu. Feet)	15.1"	15.1"

A. Coil Link Rear Suspension. Cougar's rear springs and shock absorbers work as a unit to help provide a smooth, controlled ride.

B. Power Brake; front disc, rear drum. Cougar's standard system offers a power assist swept area of 368.9 square inches of stopping power.

C. Steering Column Flex Coupling. Helps reduce road shock before it reaches driver's hands. A particularly desirable feature on irregular road surfaces.

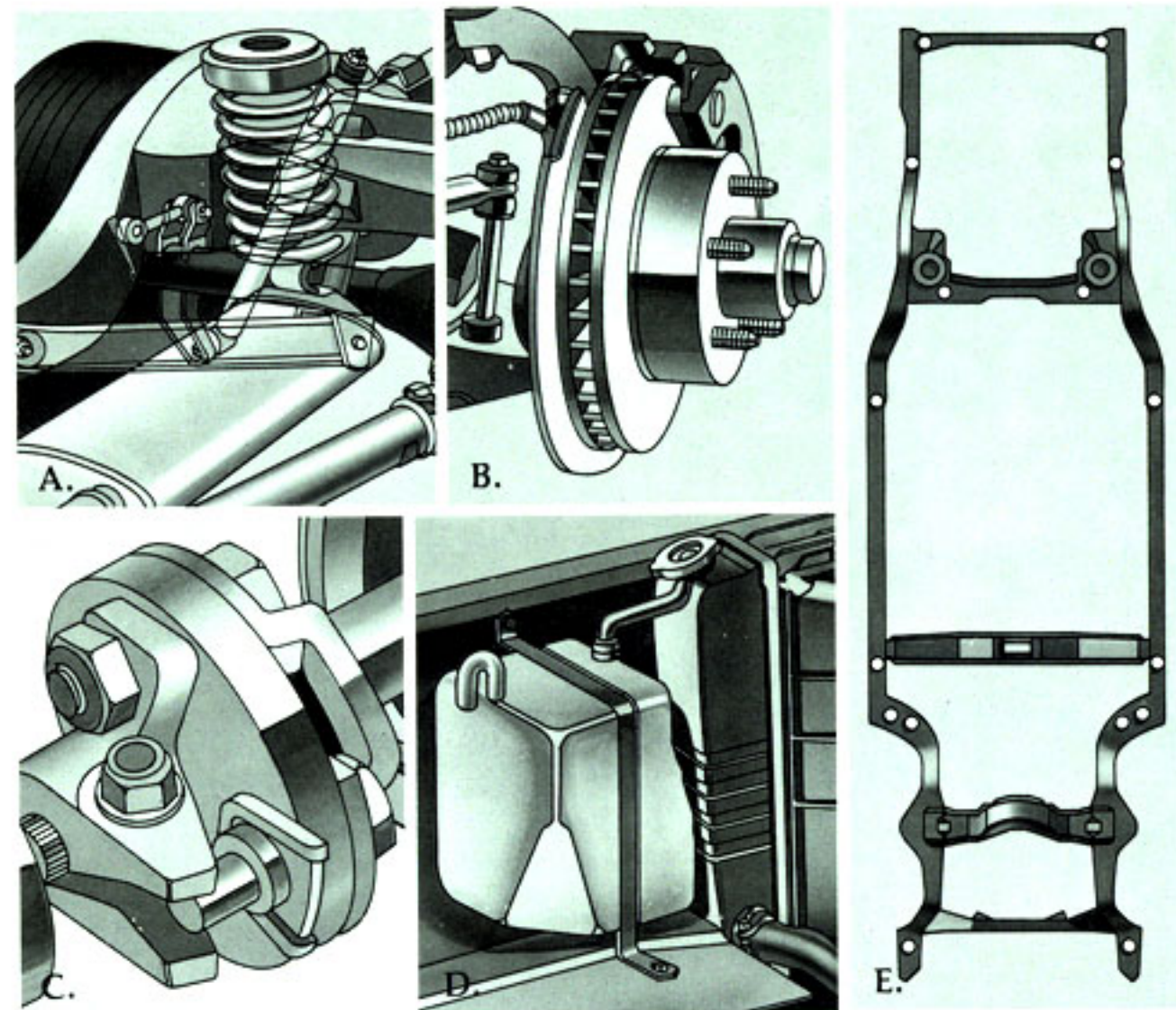

D. Closed Coolant Recovery System. Heated coolant overflow is captured and retained in the reservoir and returned to radiator automatically when it cools.

E. Body/Frame Construction. Cougar's body/frame unit has energy-absorbing perimeter frame and strategically located butyl rubber mounts to help reduce road shock and vibration from reaching the passenger compartment.



AM/FM/MPX Radio with Quad-8 Tape Player



Day/Date Clock



Cornering Lights



Tilt Steering Wheel



Space-Saver Spare Tire

COUGAR OPTIONS

PERFORMANCE RELATED

	Cougar XR-7	Cougar Brougham	Cougar
351-2V V-8 (Required in California)	X	X	X
400-2V V-8	X	X	X
High Altitude Option (Required only in High Altitude regions)	X	X	X
California Emission System (Required in Calif. NA 302 V8)	X	X	X
Higher-Ratio Axle	X	X	X
Traction-Lok Axle	X	X	X
Alternator, Heavy-Duty	X	X	X
Battery, Heavy-Duty-77 amp.	X	X	X
Sport Instrumentation (1)	X	X	X
Suspension, Cross-Country	X	X	X
Trailer-Towing Package, Heavy-Duty (Class III)	X	X	X

COMFORT & CONVENIENCE

Air Conditioning, Manual	X	X	X
Air Conditioning, Automatic Temperature Control	X	X	X
Clock, Day/Date (2)	X	X	X
Convenience Group (3)	X	X	X
Cornering Lamps	X	X	X
Defroster, Rear Window Electric (4)	X	X	X
Illuminated Entry System (5)	X	X	X
Light Group (6)	X	X	X
Mirror, Left-Hand Remote-Control	X	X	X
Mirrors, Dual Racing Remote-Control	X	X	X
Mirror, Illuminated Visor Vanity	X	X	X
Opera Window	Std.	Std.	X
Power Lock Group and deck lid release	X	X	X
Power Moonroof	X	X	X
Power Seat, Driver Bucket-6 Way	X	NA	NA
Power Seat, Flight Bench-6-Way	X	X	NA
Power Seat, Driver Twin-Comfort-6-Way (7)	X	X	NA
Power Windows	X	X	X
Radio AM	X	X	X
Radio, AM/FM/MPX	X	X	X
Radio, AM/FM/MPX with Tape Player	X	X	X
Radio, AM/FM/MPX with Search Feature	X	X	X
Radio, AM/FM/MPX with Quadrasonic Tape Player	X	X	X
Space Saver Tire	NEC	NEC	NEC
Speakers, Dual Rear-AM Radio only	X	X	X
Speed Control including Luxury Steering Wheel	X	X	X
Sport "S" Steering Wheel, Leather Wrapped	X	X	X
Tilt Steering Wheel	X	X	X
Tinted Glass, Complete	X	X	X

APPEARANCE & PROTECTION

Body Side Paint Stripes	Std.	Std.	X
Bucket Seats (8)	X	X	X
Bumper Protection Group	X	X	X
Decor Group-Cougar XR-7 (9)	X	NA	NA
Decor Option-Brougham (10)	NA	X	NA
Glamour Metallic Paint	X	X	X
Leather and Vinyl Seat Trim	X	NA	NA
Molding, Protective Body Side	X	X	X
Protection Group (11)	X	X	X
Seat Belts, Color Keyed	X	X	X
Tu-Tone Paint Option	X	X	NA
Vinyl Roof, Landau (2-door)	Std.	X	X
Vinyl Roof, Full	NA	X	X
Vinyl Roof, front (2-door)	NA	X	X
Vinyl Seat Trim	Std.	Std.	X
Wheels, Cast Aluminum-4 wheels	X	X	X
Wheels, Styled "Barcelona" and Trim Rings-4 wheels	X	NA	NA
Wheels, Styled Steel and Trim Rings-4 wheels	NA	X	X
Wheel Covers, Deluxe	NA	Std.	X
Wheel Covers, Luxury	NA	X	X
Wheel Covers, Wire	X	X	X

X - Available Std. - Standard NEC - No Extra Charge NA - Not Available
Some options have restricted availability or require other options as a requirement of availability. See your dealer for details.

- Includes unique instrument panel and cluster applique, luxury steering wheel with black deluxe trim, ammeter, oil pressure and temperature gauges, trip odometer and tachometer.
- Not available with Sport Instrumentation.
- Includes, passenger visor vanity mirror, automatic parking brake release (not available with floor shift), automatic seat back release (2-dr), trip odometer, interval wipers and bright left and right remote-control mirrors.
- Required in New York State.
- Includes activation of interior lights and illuminated keyhole by outside door handle.
- Includes the following lights; engine compartment, instrument panel courtesy, door-a-jar, glove box, ash tray, trunk, dome/map, rear door courtesy and headlamp-on warning buzzer.
- Required Decor-optional on Brougham models.
- Includes console and floor shift. Floor shift is deleted when tilt column is ordered. Available on 2-dr. models only.
- Includes Twin-Comfort Lounge seats with passenger recliner or bucket seats with console, luxury steering wheel, unique door trim, full-length bodyside moldings with color-keyed vinyl inserts, deluxe seat belts, quarter armrest pads, luxury carpeting, styled "Barcelona" wheels and dual racing mirrors—shown on page 3 & 4.
- Includes Twin-Comfort Lounge seats with passenger recliner, luxury steering wheel, deluxe seat belts and Deluxe carpeting, wide color-keyed vinyl insert bodyside moldings, 2-dr. models include quarter armrest pads.
- Includes door edge guards, front floor mats with carpet inserts, license plate frames (rear) and spare tire lock.



TESTED TOUGH

Quality Replacement Parts from Ford—Your new Mercury comes equipped with factory engineered and approved parts including a dependable Motorcraft battery, Autolite Power-Tip spark plugs, Motorcraft shock absorbers, ignition parts and Long Life oil filter. For continued top performance be sure to specify genuine Motorcraft parts whenever replacement is necessary.

Lincoln-Mercury Division reserves the right to discontinue or change specifications or designs at any time, without incurring any obligations. Some features shown or described previously are optional equipment items which are available at extra charge. Some options are required in combination with other options.



MERCURY COUGAR