

1956 FORD



Available with the new "Interceptor" Y-8 Engine of 215 h.p.
and Lifeguard Design features for greater safety

Preferred by
Law Enforcement Agencies
everywhere

FORD Police Cars

Built for long-lasting law-enforcement duty



CUSTOMLINE

Preferred year after year by the Police fleets of the nation are the distinctively styled Customline Series of cars by Ford. Available as a Tudor or Fordor, the Customline has proven its stamina through years of rugged pavement-pounding duty. The Customline Tudor, illustrated above, has extra-large doors (nearly four feet wide) for easy entrance and exit.

Both Tudor and Fordor offer interiors which provide he-man comfort for six husky six-footers. That means lots of hip, shoulder, leg and head room. Durable, easy-to-clean vinyl and fabric upholstery or special heavy-duty brown vinyl interiors available at extra cost. Among the engineering features are new easier handling Ball-Joint Front Suspension, Angle-Poised Ride and the exclusive Ford Lifeguard Design.

MAINLINE

Clean exterior lines and graceful contours give the Ford Mainline Series a well-tailored look that "belongs" in any police fleet. Illustrated at left is the Mainline Fordor . . . a real beauty to be proud of . . . with comfort features you might expect only in cars costing hundreds more. The Fordor has doors that are more than a yard wide . . . doors that are held open for your convenience by positive door checks, 2-stage type on all front doors.

In every Mainline model you also get the same engineering advances which distinguish all Fords. These and the many other fine-car features you find in a Ford are the reasons why more Fords are used in police and law enforcement work than any other make!



Customline and Mainline cars available with Ford I-6 or Y-8, Special Police Y-8 or Interceptor Y-8 engines to fit every power requirement from 137 h.p. to 215 h.p.

Versatile Station Wagons

Ready for emergencies—day or night

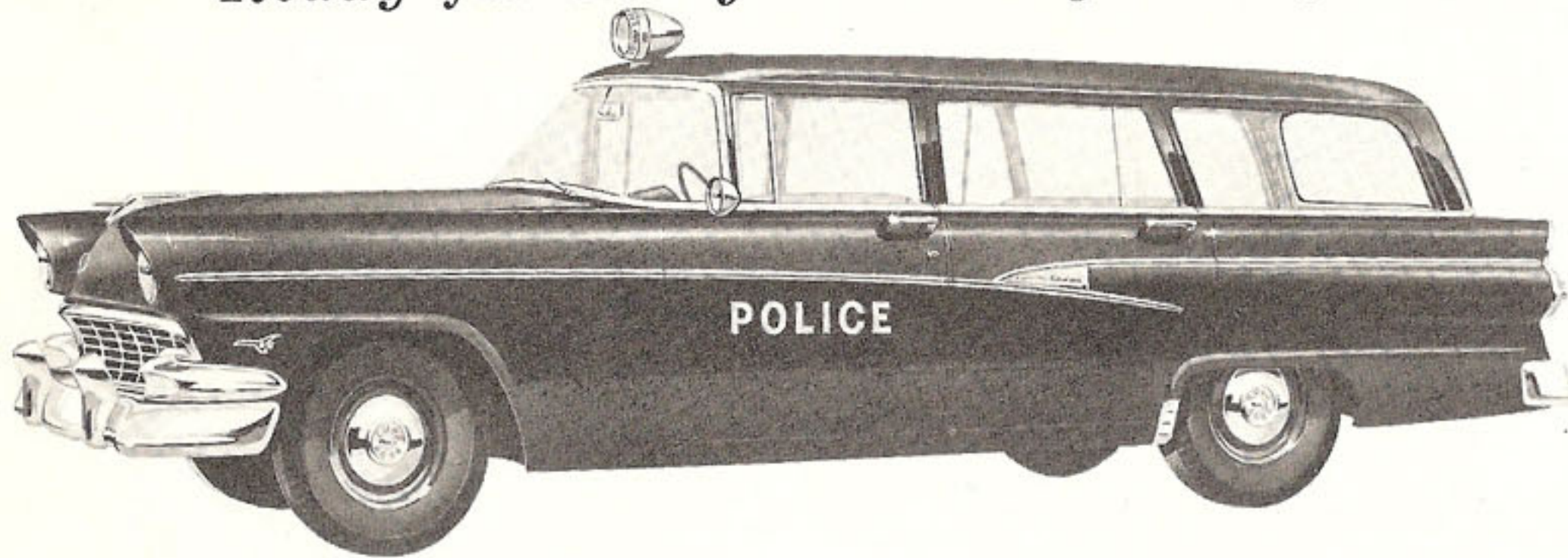

FORD COUNTRY SEDANS

Four doors plus a Stowaway second seat at which folds flush with the floor make Ford Country Sedans well suited for emergency work. The 6-passenger model (shown above) has a 2-section second seat which folds forward and down to provide over six feet of level loadspace inside the body. The 8-passenger model is equipped with a divided second seat to give easy access to a two-section rear seat that can be lifted out in a matter of minutes.

With the rear seat removed and the center seat folded down, there is nearly seven feet of level loadspace from the back of the front seat to the closed tail gate—distance to the end of open tail gate is 105.4". Five interior choices: Three woven-plastic-and-vinyl or two all-vinyl trims.



Ford Station Wagons may be ordered with a wide-opening panel-type door which stays open in all positions, or the standard tail gate which locks securely in either "down" or "up" position.

FORD RANCH WAGONS

The two-door Ranch Wagon (illustrated below) has a divided front seat and a Stowaway second seat which may be divided or undivided. The standard (undivided) seat is the same as the one used in the 6-passenger Country Sedan which provides slightly over six feet of clear space. Optional divided rear seat is the same as that used in the 8-passenger Country Sedan which provides the longer loadspace needed for ambulances.

The Ford Ranch Wagon is available in two interior trim schemes; woven plastic-and-vinyl or all-vinyl with brown ribbed linoleum on the loadspace floor. The Custom Ranch Wagon has additional outside bright-metal trim and offers three woven plastic-and-vinyl interiors in addition to the all-vinyl trim.

Ford Station Wagon engine options consist of the Ford I-6, the Special Police Y-8 or the superior-performing Interceptor Y-8.

With Ford's exclusive Lifeguard Design
for greater safety in 1956

Years of intensive research have shown that more than half of all injuries in auto accidents result from three major causes. *First*, when the driver is thrown against the steering column. *Second*, when occupants strike hard surfaces within the car. And *third*, when the doors are sprung open and occupants are hurled out of the car. Ford engineers have minimized these injury hazards with the new safety features shown here that combine to make Lifeguard Design a safer buy for police and law enforcement operation.

NEW LIFEGUARD STEERING WHEEL. Ford's brand-new, specially designed steering wheel is another great safety feature that you find "standard" on every Ford model for '56. Three equally spaced spokes from the wheel rim to a recessed deep center effectively absorb strong impact pressures and help protect the driver's chest from more serious contact with the unyielding steering column.

NEW LIFEGUARD PADDING. The composition and cellular-like structures of this optional Lifeguard padding material for the instrument panel and sun visors results in an extraordinary ability to absorb shock. Tests show it is five times as shock absorbent as foam rubber.

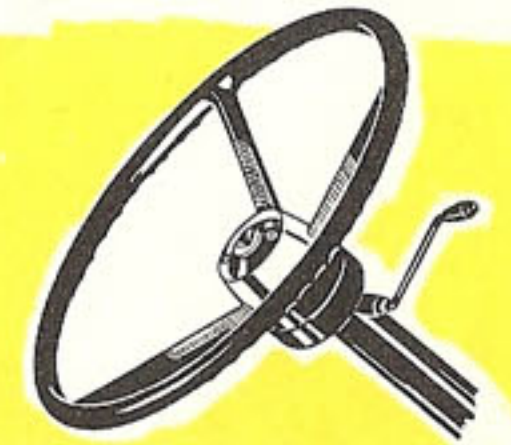

NEW FORD SEAT BELTS. These new seat belts, designed to exceed the rigid CAA requirements for aircraft, are the finest car seat belts available today. These safety items, available at extra cost for all models, front and rear, are made of strong nylon-rayon cord with buckles of die-cast aluminum quickly operated in one-hand release or adjustment. Each belt is securely anchored to husky steel plates reinforcing the steel floor structure.

NEW LIFEGUARD DOOR LATCHES. Ford's double-grip latches provide a strong, extra "door gripper" on the striker plate to help prevent the car body and door from pulling apart on vehicle impact. This greatly reduces the possibility of doors swinging open in accidents and occupants being thrown out. Closed doors also add to car structural strength to withstand impact in the event of roll-over. These Lifeguard door latches are standard on all '56 Fords.

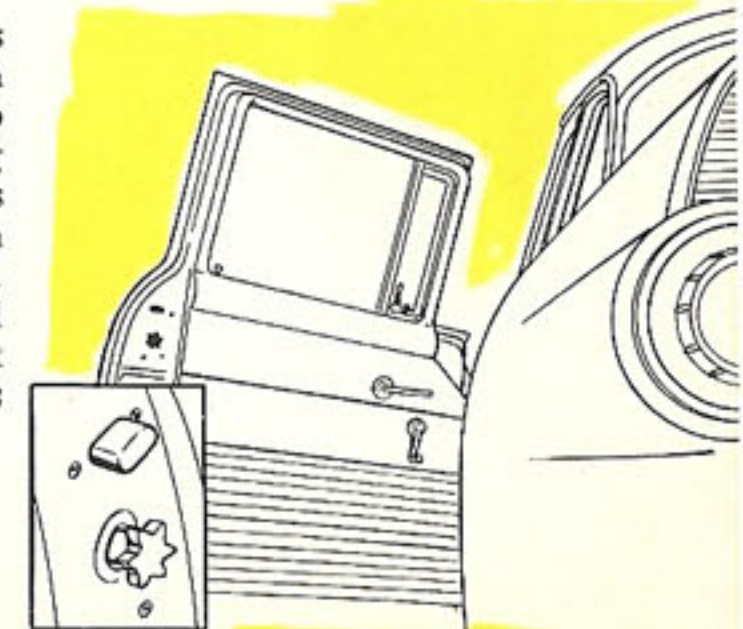

Most Modern Engine in America

The Brand-New 215-h.p. INTERCEPTOR Y-8 . . . successor to the V-8

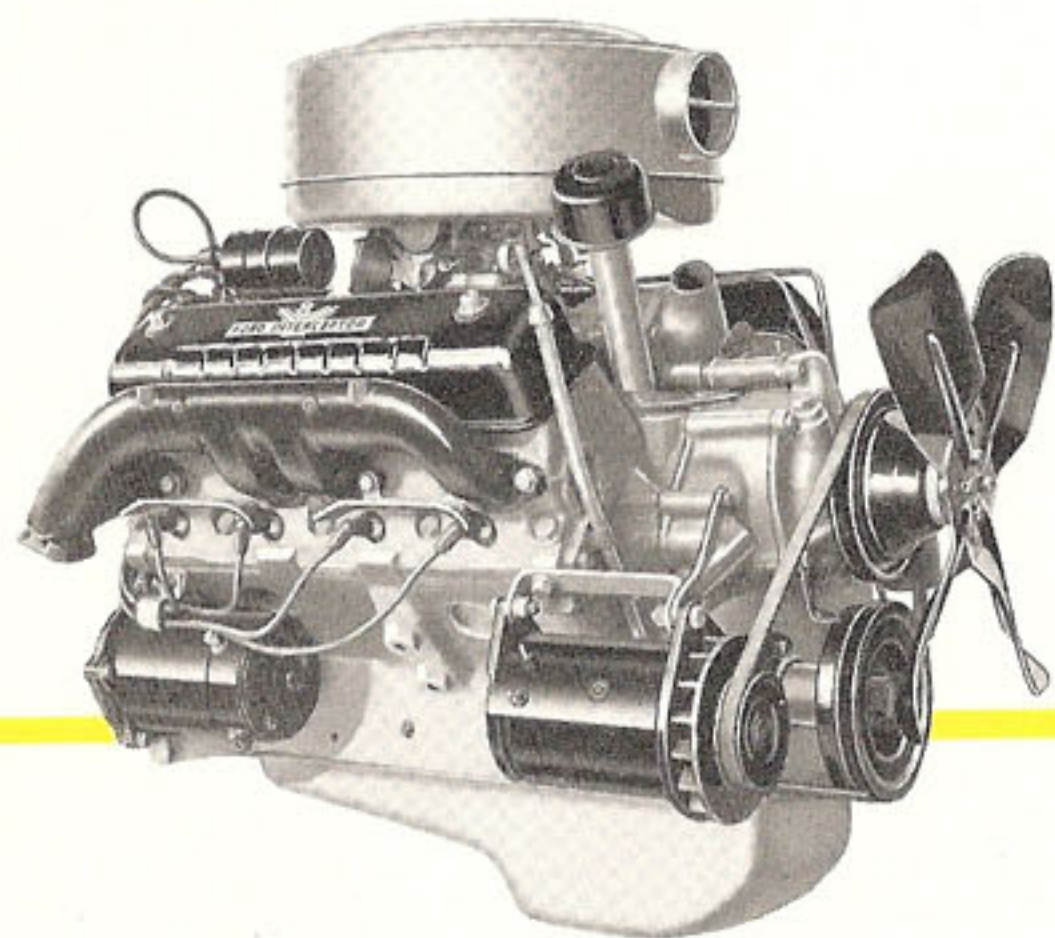

- ★ NEW POWER
- ★ SUPERIOR PERFORMANCE
- ★ LONG-LASTING DURABILITY

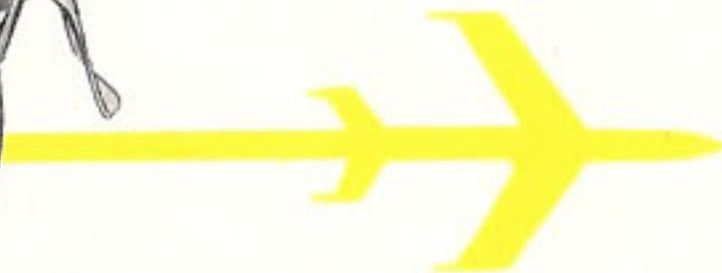

For 1956, Ford proudly presents the Interceptor Y-8, an engine that is years ahead in revolutionizing engine design. Just as the V-8 engine, pioneered in 1932, was exclusive to Ford in its field . . . the new Y-8 engine design is another *Ford first!*

Ford's new Y-8 engine design means split-second passing—greater confidence in all driving. It gets its name, Y-8, from its deep-block design which makes it run smoother, quieter, and *last longer!* Horsepower output of this 312-cu. in. engine is 215 with an 8.4 to 1 compression ratio with Fordomatic; with Conventional or Overdrive transmissions, horsepower is 210 and compression ratio is 8.0 to 1.

This new engine features a 4-barrel carburetor with integral choke and complete twin exhaust system which provide better breathing for rapid acceleration and high speeds. Unlike other designs, the additional two barrels of the 4-barrel carburetor are brought into use by the engine's needs, not by the gas pedal position. The entirely new automatic choke is an integral part of Ford's famous Automatic Power Pilot, to give better starts and provide efficient fuel control automatically.

There's a brand-new 12-volt electrical system to provide faster starts . . . better ignition at high speeds . . . and more power to handle emergency accessories.

Anti-fouling 18 mm. spark plugs, a *Ford first*, are standard in the new Y-8. These plugs, because they have more room between plug core and shell, resist fouling up to 3 times as long as conventional plugs . . . help curb pre-ignition as well as misfiring. The exclusive tapered seat design permits positive seating of plugs in cylinder head without use of gaskets.

And among the many other *extra* features are Turbo-wedge combustion chambers, free-turning overhead valves, high-lift camshaft, three-piece oil rings with chromed-steel segments for more efficient oil sealing and longer life—all *standard* with this exclusive Ford Interceptor Y-8 engine available for all police and emergency vehicles.

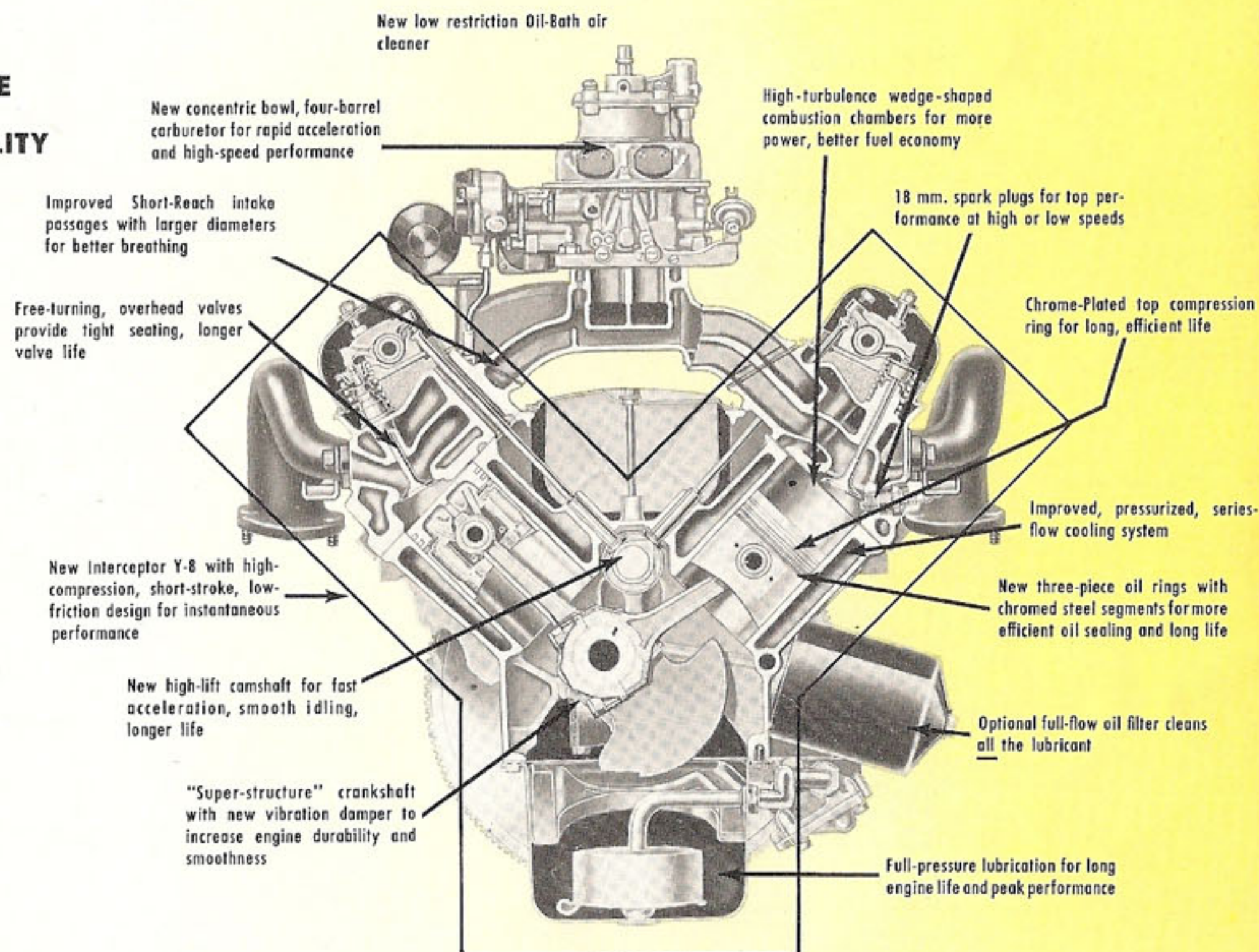

BASIC SPECIFICATIONS

Type	8-cyl., 90°-Y, overhead-valve	Horsepower (at 4600 r.p.m.)	215*	210†
Displacement (cu. in.)	312	Torque (lb.-ft. at 2600 r.p.m.)	317*	312†
Bore x Stroke	3.80 x 3.44	Compression ratio (to 1)	8.4*	8.0†

*With Fordomatic Drive. †With Overdrive or Conventional Transmissions.

3 NEW Additional Engine Choices to Meet Specific Requirements

202-H.P. SPECIAL POLICE Y-8

As with the great new "Interceptor" Y-8, the Special Police Y-8 is exclusively new! This engine is an adaption of the outstanding Ford Thunderbird engine which won fame in 1955. With 292-cu. in. displacement, it has 202 h.p. and an 8.4 to 1 compression ratio with Fordomatic and 200 h.p. with a compression ratio of 8.0 to 1 with Conventional or Overdrive. It features 4-barrel carburetion with automatic choke, turbo-wedge combustion chambers, dual exhausts, 18mm. turbo-action spark plugs, and the new 12-volt electrical system, in addition to Ford's gas-saving automatic Power Pilot and low-friction design. Result—you get power *plus* on regular gas. This engine is available on all Ford police and emergency use vehicles for '56.

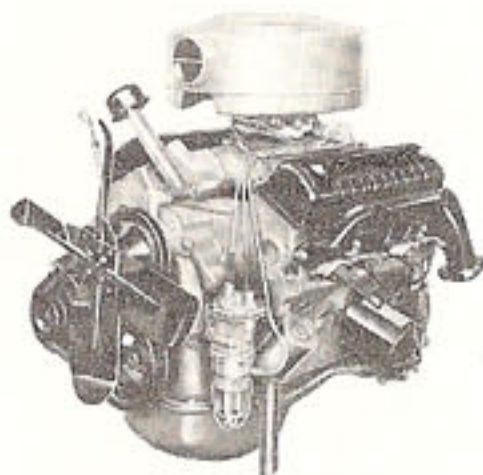

BASIC SPECIFICATIONS

Type	8-cyl., 90°-Y, overhead-valve
Displacement (cu. in.)	292
Bore x Stroke (in.)	3.75 x 3.30
Horsepower (at 4600 r.p.m.)	202* 200†
Torque (lb.-ft. at 2600 r.p.m.)	289* 285†
Compression ratio (to 1)	8.4* 8.0†

176-H.P. FORD Y-8

Another new engine for 1956 is the 176-h.p. Ford Y-8 which has the same basic features as the Special Police Y-8 but with 272-cu. in. displacement. This engine, which is available in Customline and Mainline Series only, has a 2-barrel carburetor with automatic choke and single exhaust. It has an 8.4 to 1 compression ratio with Fordomatic—with Overdrive or Conventional transmissions an 8.0 to 1 compression ratio is used to obtain 173 h.p. New 12-volt electrical system provides faster starts . . . better ignition at high speeds.

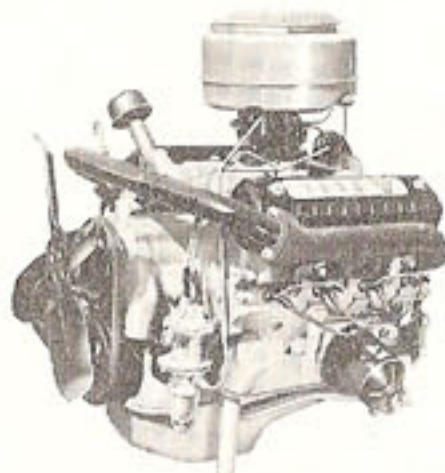

BASIC SPECIFICATIONS

Type	8-cyl., 90°-Y, overhead-valve
Displacement (cu. in.)	272
Bore x Stroke (in.)	3.62 x 3.30
Horsepower (at 4400 r.p.m.)	176* 173†
Torque (lb.-ft. at 2400 r.p.m.)	264* 260†
Compression ratio (to 1)	8.4* 8.0†

137-H.P. FORD I-6

The new Ford I-6 is the most modern, deep-block, low-friction Six in *any American-made car*. Like the Y-8's, the Six has deep-block construction, with the block extending well below the center of the crankshaft for extra rigidity. Among the important advancements in this new 223-cu. in. displacement Six are a higher compression ratio (8.0 to 1) for greater efficiency, Ford's new 12-volt electrical system, and advanced 18 mm. spark plugs with new, anti-erosion electrodes for peak efficiency, longer spark plug life. This 137-h.p. performer is available in all '56 Ford models with Conventional, Overdrive or Fordomatic transmissions.

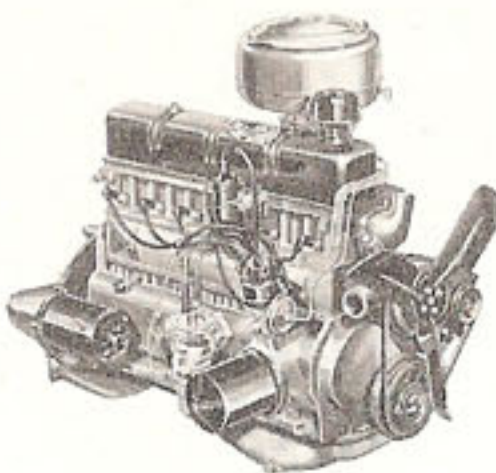

BASIC SPECIFICATIONS

Type	6-cyl., in-line, overhead-valve
Displacement (cu. in.)	223
Bore x Stroke (in.)	3.62 x 3.60
Horsepower (at 4200 r.p.m.)	137
Torque (lb.-ft. at 1600-2600 r.p.m.)	202
Compression ratio (to 1)	8.0

*With Fordomatic Drive

†With Overdrive or Conventional Transmissions

3 Transmission choices . . . tailored to your engine selection

1. Speed-trigger FORDOMATIC— instant response at your toe-touch

For 1956, Ford offers you the easiest, smoothest no-shift driving of any car at any price. Fordomatic Drive gives you instant action at the touch of your toe and provides the extra GO to "get out and around" slower moving cars and trucks in traffic.

Here's How It Works: With the selector set at Drive (DR) you whisk away in intermediate gear, automatically shifting into direct drive. For extra-fast, extra-powerful starts, merely press the accelerator to the toe-board and you flash away in low, shifting automatically to intermediate and direct drive.

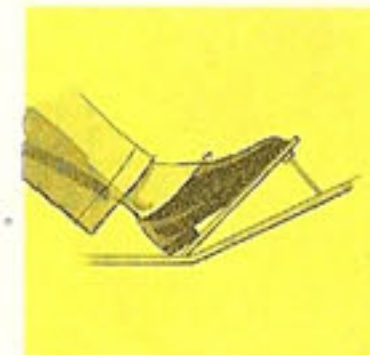

2. Gas-saving OVERDRIVE— offers fuel savings up to 15%

Ford Overdrive is an automatic "4th gear" that lets your engine loaf along at 35 miles an hour while your car is doing 50! It gives smooth, quiet, pleasant "cruising" and at the same time conserves gas! In fact, Ford Overdrive saves you up to 15 cents on every gas dollar. By putting the automatic "4th gear" into operation with Overdrive you maintain car speed while engine revolutions are reduced 30%!



3. New standard CONVENTIONAL— gives easier shifting

The 1956 Conventional Drive has high torque transmitting capacity . . . which means more power to the rear wheels. It's teamed with Ford's husky semi-centrifugal clutch plus suspended clutch pedal for easy, quiet manual shifting.

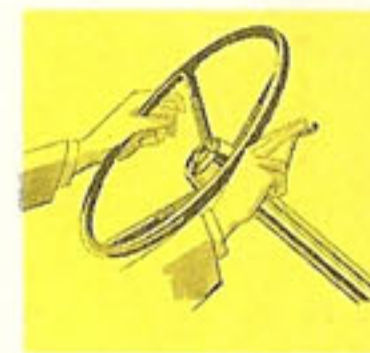

Plus—Torque-Tailored REAR AXLES

An important feature in the 1956 Ford which will provide better all-around performance, is the availability of tailored rear axle ratios for police and emergency work. Axle ratios for each engine and transmission combination are torque-tailored to provide the best over-all performance for your particular area.

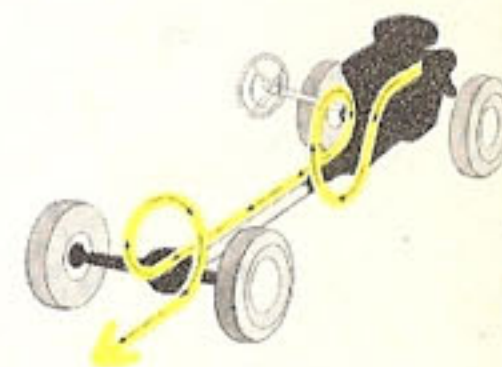

Only Ford offers all these advanced features for easy-riding, longer-lasting service

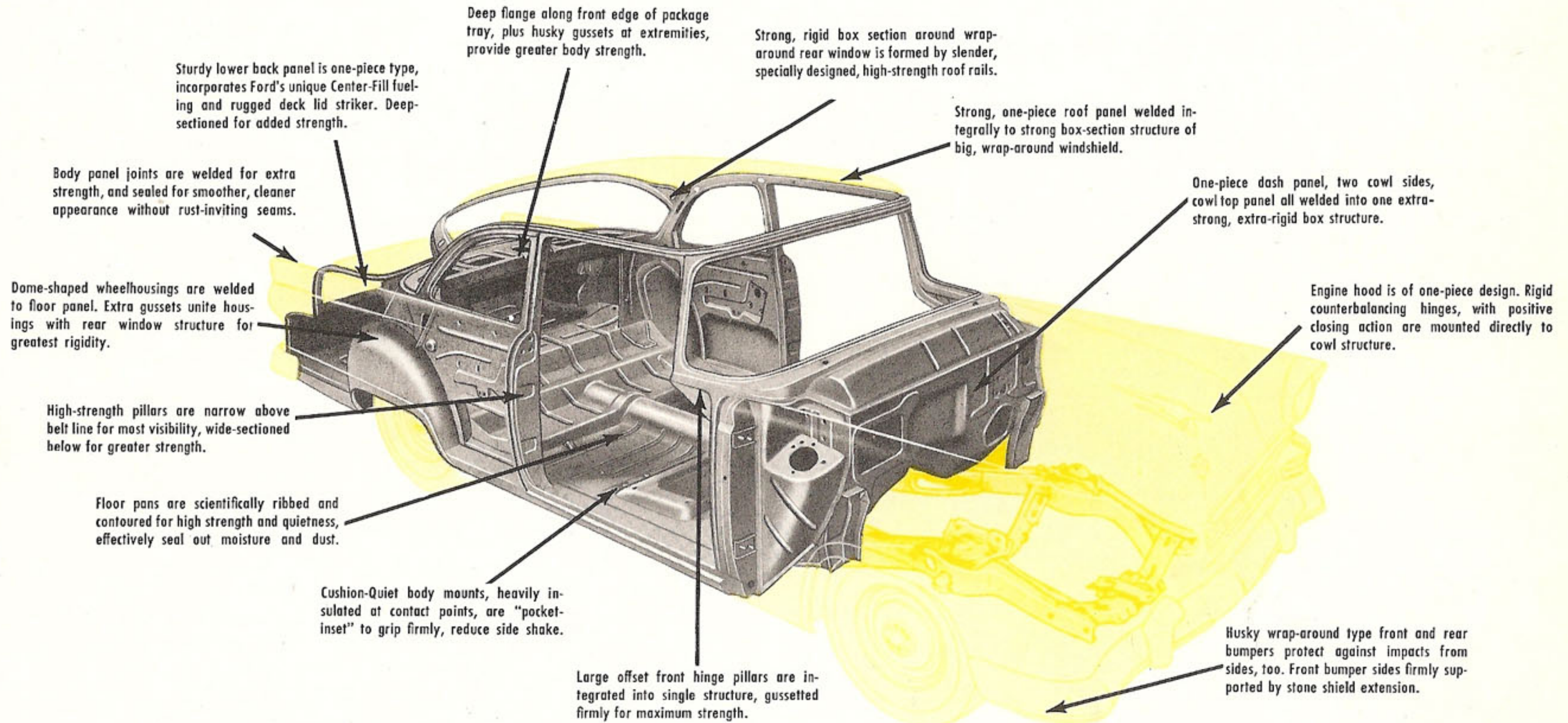

Superior riding characteristics of the new '56 Ford

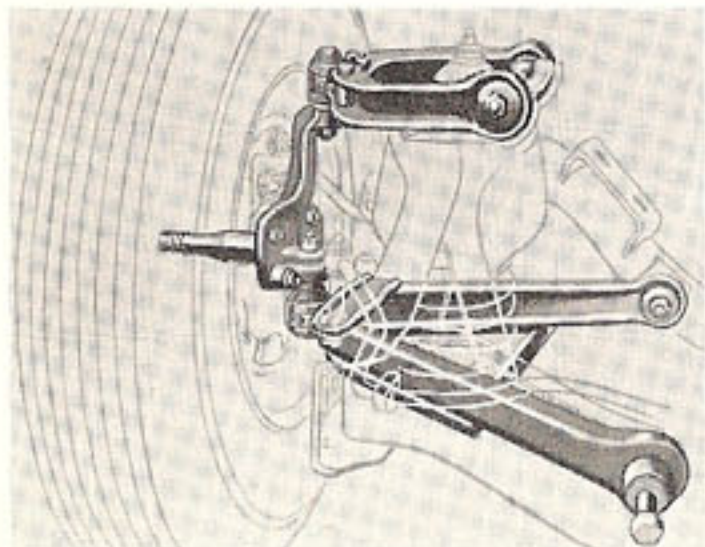

BALL-JOINT SUSPENSION, the most modern front suspension available, provides effortless handling on any type road! Wheel movement—up-and-down, left or right—centers around ball joints that can't bind or get out of line. Forged steel parts and resilient rubber bushings require less maintenance.

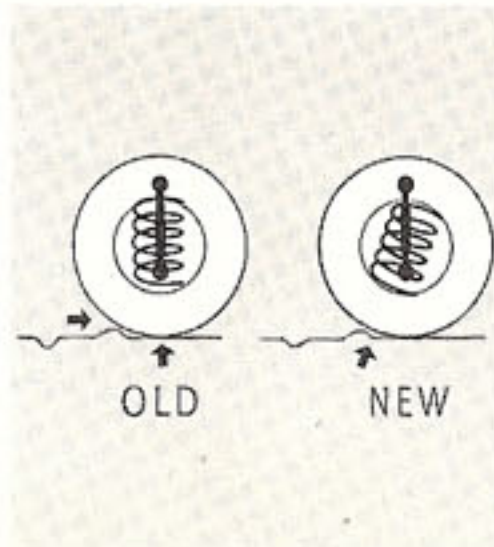

ANGLE-POISED RIDE practically "floats" your passengers over rough roads! Springs are tilted to absorb road shock from the front as well as straight up and down. This gives passengers and driver a feather-soft ride—even reduces the little bumps they receive on paved roads, and makes the ride smoother on any road.

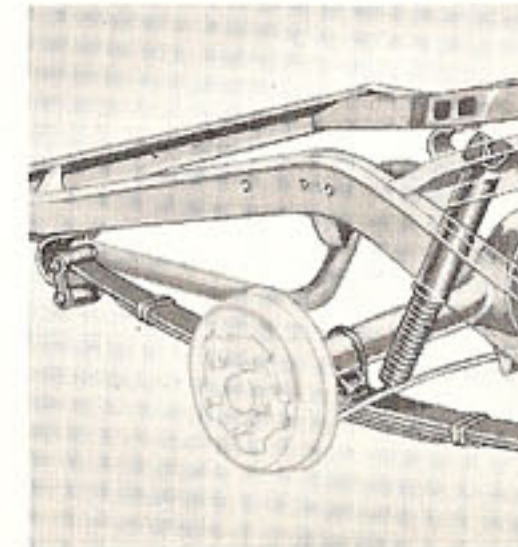

VARIABLE-RATE REAR SUSPENSION with long rear springs and tension-type shackles gives smooth, easy action over small road bumps, controlled action over big bumps. Starting and stopping are smoother too, because Ford's Hotchkiss drive uses rear springs to cushion severe braking and accelerating forces.

Factory-installed options for greater efficiency, economy, comfort

ACCESSORIES and options

OBTAINABLE THROUGH YOUR FORD DEALER



30-amp low cut-in, 40-, 50- or 60-amp generator; 30- or 50-amp alternator-rectifier system; plus former 6-volt electrical system components available to fit most radio requirements.

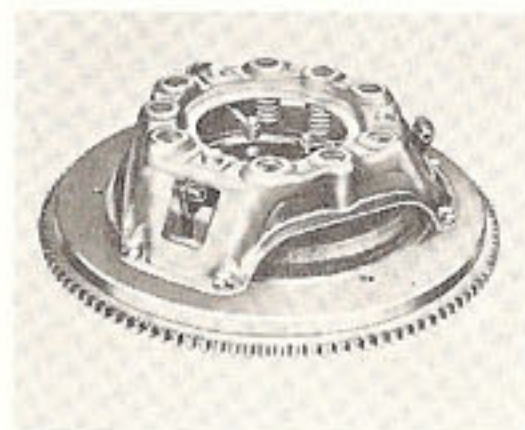

Heavy-duty 11" dia. clutch with ball-type release bearing having fitting for pressure lubrication built to take hard-wearing effects of rugged driving. (Standard with Interceptor Y-8.)

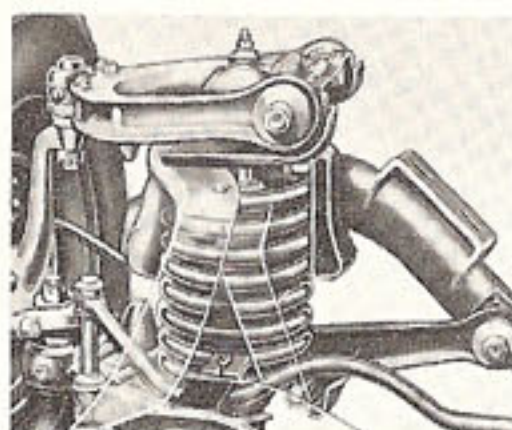

Heavy-duty front springs, heavy-duty shock absorbers give longer life. Heavy-duty variable-rate rear springs (with 6 leaves), heavy-duty diagonally mounted rear shock absorbers.

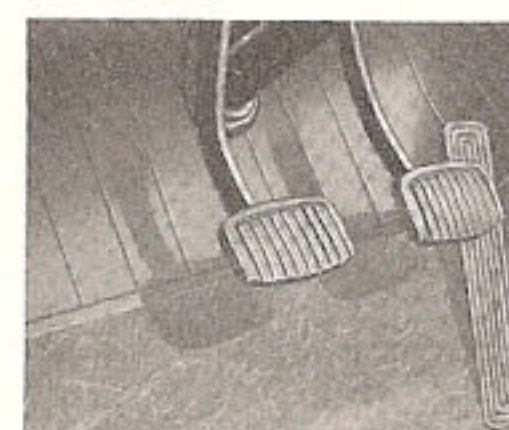

Thick, heavy-duty floor mats, front and rear, to reinforce normal wear points. Ideal for police service where there is excessive wear, especially around pedals and in the front seat area.

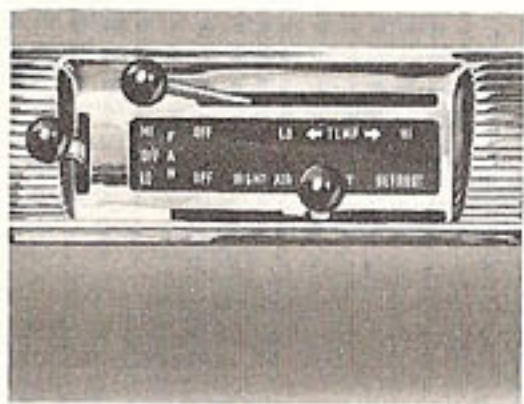

Ford's MagicAire Heating-Ventilation system controls heat distribution for warmth and defrosting, reduces window fogging. Recirculating type heater-defroster also available.



Special brake linings for Ford's double-sealed brakes mean longer lining life and more uniform braking performance. Swift Sure power brakes also optional at extra cost for all models.



Combination fuel and vacuum pump for positive w/s wiper operation included with Overdrive or Fordomatic, optional at extra cost with standard transmission. (Std. with Interceptor Y-8.)



Specially designed heavy-duty Ford radiator has larger frontal area plus extra-cooling fan for improved cooling under extreme operation and temperature conditions. (Std. with Interceptor Y-8.)

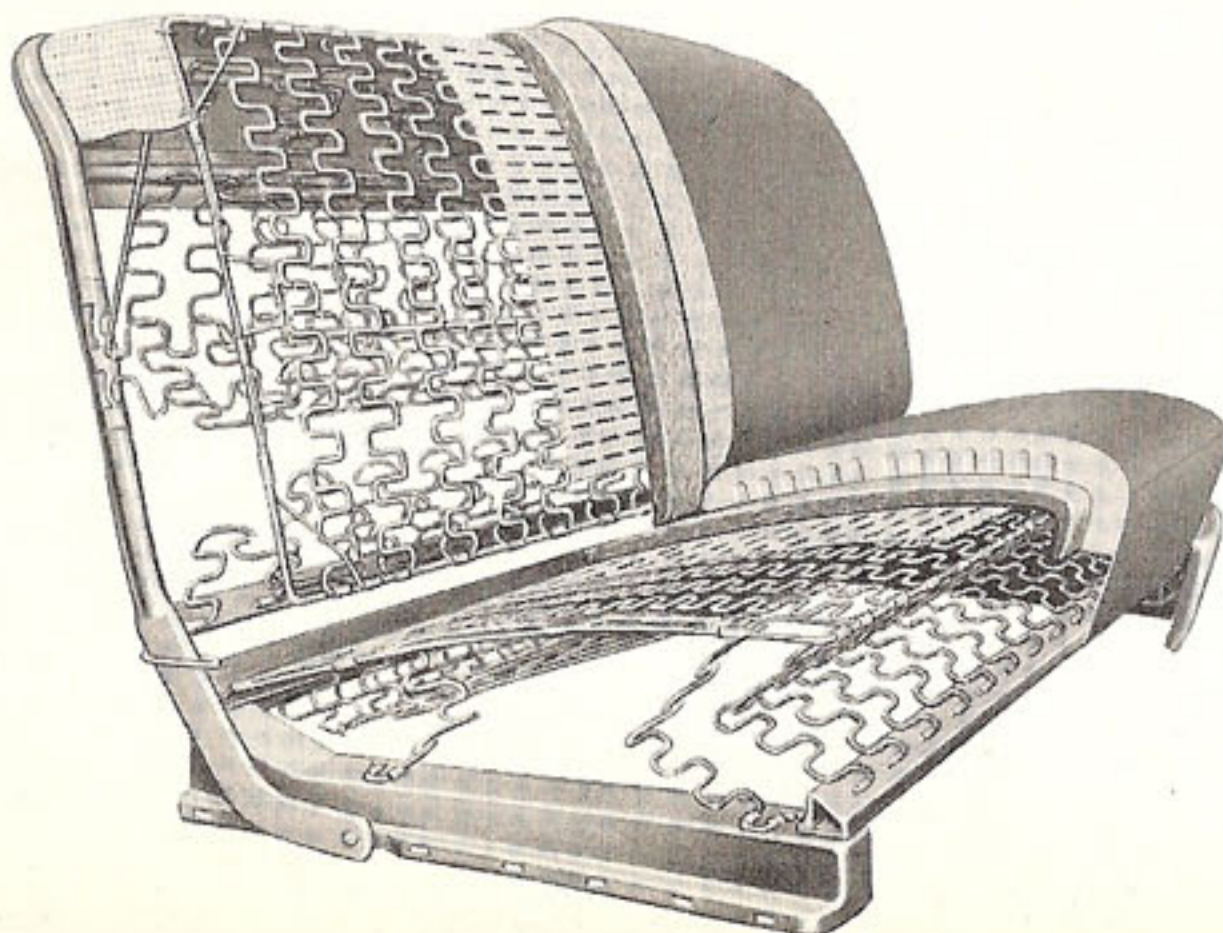

Heavy-Duty, Greater-Comfort Seats

Order your '56 Ford police sedans equipped with these special "24-hour duty" front and rear seats. They have heavy-gage springs in cushions and seat backs, with either rubberized-hair or foam-rubber pads in cushions for greater comfort and durability. Washable, long-wearing dark brown vinyl upholstery and interior trim, in place of standard upholstery and trim, is also available at extra cost.

- ★ NEW FORD SEAT BELTS*
- ★ ONE-QUART FIRE EXTINGUISHER
- ★ SPOTLIGHT
- ★ FULL TIRE CHAINS
- ★ TURN INDICATORS*
- ★ BACK-UP LIGHTS*
- ★ AUTO-WIPE WINDSHIELD WASHER*
- ★ OUTSIDE REAR VIEW MIRROR*
- ★ GLAREPROOF INSIDE REAR VIEW MIRROR
- ★ BUMPER GUARDS
- ★ COURTESY AND MAP LIGHT
- ★ ENGINE COMPARTMENT LIGHT
- ★ GLOVE COMPARTMENT LIGHT
- ★ LUGGAGE COMPARTMENT LIGHT
- ★ AUTOMATIC CIGAR LIGHTER*
- ★ ELECTRIC CLOCK*
- ★ I-REST TINTED SAFETY GLASS*
- ★ GOVERNOR*
- ★ H.D. FRONT AND REAR FLOOR MATS
- ★ POWER STEERING*
- ★ POWER BRAKES*
- ★ POWER-LIFT WINDOWS (Driver Controlled)*

*also factory-installed options.

1956 Ford Police Car SPECIFICATIONS

ENGINE DATA	INTERCEPTOR Y-8	SPECIAL POLICE Y-8	FORD Y-8	FORD I-6
Bore x Stroke, in.	3.80 x 3.44	3.75 x 3.30	3.62 x 3.30	3.62 x 3.60
Displacement, cu. in.	312	292	272	223
Taxable Horsepower	48.21	45.00	42.05	31.54
Brake h.p. at r.p.m.	210 @ 4600 [▲]	200 @ 4600 [▲]	173 @ 4400 [▲]	137 @ 4200 [▲]
	215 @ 4600 [●]	202 @ 4600 [●]	176 @ 4400 [●]	
Compression ratio	8.0 to 1 [▲]	8.0 to 1 [▲]	8.0 to 1 [▲]	8.0 to 1 [▲]
	8.4 to 1 [●]	8.4 to 1 [●]	8.4 to 1 [●]	
Torque, lb.-ft. at r.p.m.	312 @ 2600 [▲]	285 @ 2600 [▲]	260 @ 2400 [▲]	202 @ 2600 [▲]
	317 @ 2600 [●]	289 @ 2600 [●]	264 @ 2400 [●]	1600-2600 [▲]
Oil capacity with filter	6 qts.	6 qts.	6 qts.	5 qts.
Cooling Capacity:				
without heater	19½ qts.	19 qts.	19 qts.	14½ qts.
with heater	20½ qts.	20 qts.	20 qts.	15½ qts.
▲With Overdrive or Conventional Trans.		●With Fordomatic Drive		

CLUTCH DATA	
Type	Semi-centrifugal, dry, single plate
Outside diameter, in.	11½
Frictional Area, sq. in.	113.1
Pilot bearing	Oil-impregnated, sintered bronze
Throwout bearing	Permanently lubricated, ball
§Heavy-duty 11" type with fitting for pressure lubrication of throwout bearing included on Interceptor Y-8, optional at extra cost with other engines.	

TRANSMISSION DATA	
Conventional Drive	
Type	Selective gear, 3 speeds forward, one reverse
First gear ratio	2.49
Second gear ratio	1.59
Third gear ratio	1.00
Reverse gear ratio	3.15
Overdrive (optional at extra cost)	
Type	3-speed, with automatic planetary fourth speed
First gear ratio	2.49
Second gear ratio	1.59
Third gear ratio	1.00
Fourth gear ratio	0.72
Reverse gear ratio	3.15
Cut-in of fourth	
Return to third	

ENGINE FEATURES, ALL MODELS: Deep-block construction; short-stroke, low-friction design; high-turbulence combustion chambers plus high-compression for highest operating efficiency. Precision-molded alloy iron crankshaft with vibration damper. Tin-plated superfitted aluminum alloy pistons; 3 rings, top ring chrome-plated, second ring phosphate-coated, circumferential-type oil ring with chrome-plated, steel rails. Free-turning intake and exhaust valves; high-lift, precision-molded alloy iron camshaft, silent chain drive, 13-pound pressure, series flow cooling system with positive-action thermostat. Full pressure lubrication, full-flow oil filter; positive crankcase ventilation. Thermostatic manifold heat control valve. Twelve-volt electrical system; 18-mm. spark plugs with anti-erosion electrodes; weatherproof ignition; high-torque starting motor, anti-kickout drive; 30-amp., high-capacity generator; 66-plate, 55-amp.-hr. battery, 30-amp. low cut-in generator; 40-, 50- or 60-amp. heavy-duty generators and 78-plate, 70-amp.-hr. battery available. Alternator-rectifier systems and former 6-volt electrical system also available.

INTERCEPTOR Y-8: Overhead-valve, 90°-Y type, 5 main bearings, precision steel-backed, copper-lead inserts. Heavy-duty radiator with extra-cooling fan. Double Twin-Jet (4-barrel), concentric-bowl, downdraft carburetor with automatic choke; dual exhaust system; diaphragm-type, mechanical fuel pump with integral vacuum-booster unit for positive windshield wiper action; low-restriction oil bath air cleaner. Other special equipment included with Interceptor Y-8: (sedans only) heavy-duty front springs and rear springs plus special brake linings.

SPECIAL POLICE Y-8: Overhead-valve, 90°-Y type, 5 main bearings, precision steel-backed, copper-lead inserts. Double Twin-Jet (4-barrel), concentric-bowl downdraft carburetor with automatic choke; low-restriction oil bath air cleaner; dual exhaust system; diaphragm-type mechanical fuel pump#.

FORD Y-8: Overhead-valve, 90°-Y, 5 main bearings, precision steel-backed babbitt inserts. Twin-Jet downdraft carburetor with integral automatic choke and single exhaust system, oil bath air cleaner, diaphragm-type mechanical fuel pump#.

FORD I-6: Overhead-valve, in-line type, 4 main bearings, precision steel-backed babbitt inserts. Unit-design, single downdraft carburetor with manual choke and single exhaust system; oil bath air cleaner; diaphragm-type mechanical fuel pump#.

#Combination fuel and vacuum pump, optional at extra cost, is factory installed on all cars sold in states requiring positive-action windshield wiper operation and on all cars equipped with Overdrive or Fordomatic.

FORDOMATIC (optional at extra cost): Single-stage, 3-element, hydraulic torque converter with automatic planetary gear train; forced air cooling; illuminated Safety-Sequence Selector. Automatic "low gear" starts with wide-open throttle; automatic intermediate gear; oil-level dip stick in engine compartment. Planetary gear ratios: low—2.40:1, intermediate—1.47:1, direct—1.00:1, reverse—2.00:1.

DOUBLE-DROP FRAMES: 5-cross-member type; heavy box-section side rails; K-bar construction. Station Wagons have specially designed No. 4 and No. 5 cross members.

ANGLE-POISED BALL-JOINT FRONT SUSPENSION: Rubber-bushed, tilted, transverse-link type with ball joints; tailored-to-weight coil springs with tubular shock absorbers; rubber-bushed, 3-piece ride stabilizer. Heavy-duty springs and extra-capacity shock absorbers standard on Interceptor Y-8 sedans; optional at extra cost on other sedans.

VARIABLE-RATE REAR SUSPENSION: 5-leaf, semi-elliptic springs, rubber-bushed brackets and tension-type shackles; friction control inserts between spring leaves; diagonally mounted tubular shock absorbers. Heavy-duty 6-leaf springs and extra-capacity shock absorbers standard on Interceptor Y-8 sedans, optional at extra cost on other sedans. Station Wagons have 7-leaf, semi-elliptic springs with inserts between top 4 leaves.

REAR AXLE: Semi-floating type with hypoid gears and induction hardened shafts. Composite-type housings on Station Wagons and on Interceptor Y-8 sedans.

Gear ratios:	Interceptor Y-8			Special Police or Ford Y-8			Ford I-6		
	Conv.	Over.	Fordo.	Conv.	Over.	Fordo.	Conv.	Over.	Fordo.
Sedans:									
Std.	3.73	3.92	3.54	3.78	3.89	3.22	3.89	4.11	3.22
Opt.	—	—	3.31	3.89	3.78	3.55	4.11	3.89	3.55
Wagons:									
Std.	4.09	4.27	3.54	4.09	4.27	3.54	4.09	4.27	3.54
Opt.	4.27	—	—	4.27	—	—	4.27	—	—

DOUBLE-SEAL HYDRAULIC BRAKES: 11-inch diameter, composite drums; 4-wheel servo type; suspended pedal; dash-mounted master cylinder with heat-resistant components, 180-sq. in. lining area on sedans; 191 sq. in. area on Station Wagons; hand brake operates rear brakes. Special linings standard on Interceptor sedans; heavy-duty type optional at extra cost on other sedans. Swift Sure power brakes optional at extra cost on all models.

STEERING SYSTEM: Symmetrical linkage with spring-loaded ball-stud in steering cross link; worm-and-roller type gear; anti-friction bearings in gear box and steering column, 18" dia. Lifeguard steering wheel; 25.3 to 1 over-all steering ratio; approx. 41 ft. turning diameter. Master-Guide Power Steering optional at extra cost on all models.

WHEELS AND TIRES: Black sidewall tubeless tires standard; white sidewalls optional at extra cost. Tires and tubes available on all models, also 6.00 x 16 4- or 6-ply on sedans.

	Sedans & 6-pass. Wagons	8-pass. Wagon
Standard	6.70 x 15 4-ply	7.10 x 15 4-ply
Optional	6.70 x 15 6-ply; 7.10 x 15 4-ply	7.10 x 15 6-ply

EXTERIOR DIMENSIONS (inches): 115¼ wheelbase; 58 front and 56 rear treads; over-all length, sedans 198.5, station wagons 197.6; over-all width 75.9; over-all height (with design load), sedans 60.4, station wagons 62.2.

	Leg Room			Hip Room			Head Room		
	Front	Center	Rear	Front	Center	Rear	Front	Center	Rear
Sedans...	44.3	—	41.9	60.5	—	60.3	34.9	—	33.9
6-pass. Wagons	44.3	—	43.0	60.5	—	59.7	36.3	—	36.5
8-pass. Wagon	44.3	39.8	37.4	60.5	60.3	43.8	36.3	36.4	33.8

Station wagon loadspace dimensions: Length with undivided-type second seat folded forward—to closed tail gate, 74.0; to closed optional panel-type door, 75.8. Length with divided-type second seat folded down—to closed tail gate; 82.9 to closed panel-type door, 84.3. Width—forward of wheel housings, 60.5; at wheel housings, 42.5; at rear opening, with door 46.9", with tail gate 45.3" Max. height, floor to headlining, 37.7

Prices: Some of the items listed above or otherwise referred to in this folder are at extra cost. For the price of the model with equipment the customer desires, he must consult an authorized Ford Dealer.

STANDARD AND OPTIONAL EQUIPMENT:

	Main-line	Custom-line	Ranch Wagon	Custom Ranch Wagon	Country Sedan
Air ducts for body ventilation	X	X	X	X	X
Arm rests: on each front door	O	X	O	X	X
on rear doors	O*	X*	—	—	X
at sides of rear seats	O†	X†	O	X	—
Ash trays: in instrument panel	X	X	X	X	X
in front seat back	O*	X*	—	—	X
in rear seat arm rests	O†	X†	O	X	—
Bumpers, front and rear, with gravel deflectors and bumper guards	X	X	X	X	X
Cigarette lighter, automatic pop-out type	O	X	O	X	X
Clock, electric type	O	O	O	O	O
Coat hooks, each side, rear compartment	X	X	X	X	X
Door latches, Lifeguard, double-grip type	X	X	X	X	X
Floor mats: black rubber	X	X	X	X	X
heavy-duty type	O	O	O	O	O
Foot rest, at rear of front seat	X	X	X	X	X
Gas tank: center-fill, 17.5 gal.	X	X	—	—	—
left-side fill, 19 gal.	—	—	X	X	X
Hood latch, outside control	X	X	X	X	X
Horns, twin electric type	X	X	X	X	X
Ignition switch, 4-way type	X	X	X	X	X
Instrument panel: plain knobs	X	—	X	—	—
knobs w/bright inserts	—	X	—	X	X
Lifeguard padding	O	O	O	O	O
Lights, exterior, sealed beam headlights, parking lights, dual stop and tail lights and license plate lamp	X	X	X	X	X
Lights, interior: rheostat controlled panel	X	X	X	X	X
dome with integral switch	X	X	X	X	X
dome operated by doors	—	X	—	X	X
Mirror, rear view, inside double swivel	X	X	X	X	X
Parcel compartment with locking latch	X	X	X	X	X
Seat cushions: foam rubber in front only	O	X	—	—	—
foam rubber in all seats	O	O	—	X	X
heavy-duty springs in cushions and backs	O	O	—	—	—
Steering wheel: Lifeguard Design	X	—	X	—	—
with horn button	O	X	O	X	X
with horn ring	O	X	—	—	—
Sun visor: driver's side only	X	—	X	—	—
both sides	O	X	O	X	X
Lifeguard padding	O	O	O	O	O
Tools: bumper jack, comb. jack handle and tire wrench	X	X	X	X	X
Trim, exterior: bright metal:					
windshield and back	—	X	—	X	X
window molding	—	—	—	—	X
body belt molding	—	X	—	X	X
body side molding	—	X	—	—	X
stone guard at rear fenders	X	X	X	X	X
Trim, interior: cloth-and-vinyl	X	X	—	—	—
woven plastic-and-vinyl	O	O	X	X	X
all-vinyl	O	O	X	X	X
Windshield wipers, dual vacuum-operated#	X	X	X	X	X

(X = std.; O = opt.; — = not avail.)

*Fordor Sedans. †Tudor Sedans.

†The following additional items are standard on the 8-passenger Country Sedans: 2-tone paint on the instrument panel, chrome finished rear view mirror and arm, painted steering wheel and wide body side trim. Divided-type Stowaway Seat, standard on the 8-passenger Country Sedan is also available in 6-passenger model and in Ranch Wagons. Panel-type rear door in place of standard tail gate is available for all station wagons.

The specifications contained herein were in effect at the time this folder was approved for printing. The Ford Division of Ford Motor Company reserves the right to discontinue models at any time or change specifications or design, without notice and without incurring obligation.



FORD Division of FORD MOTOR COMPANY, Dearborn, Michigan